

A1S62TCTT-S2 Heating-Cooling Temperature Control Module  
A1S62TCTTBW-S2 Heating-Cooling Temperature Control Module  
with Wire Breakage Detection Function

## User's Manual

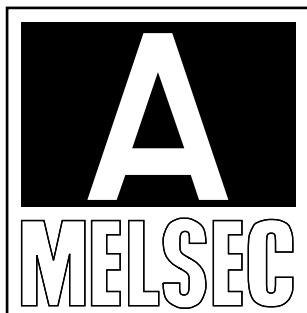

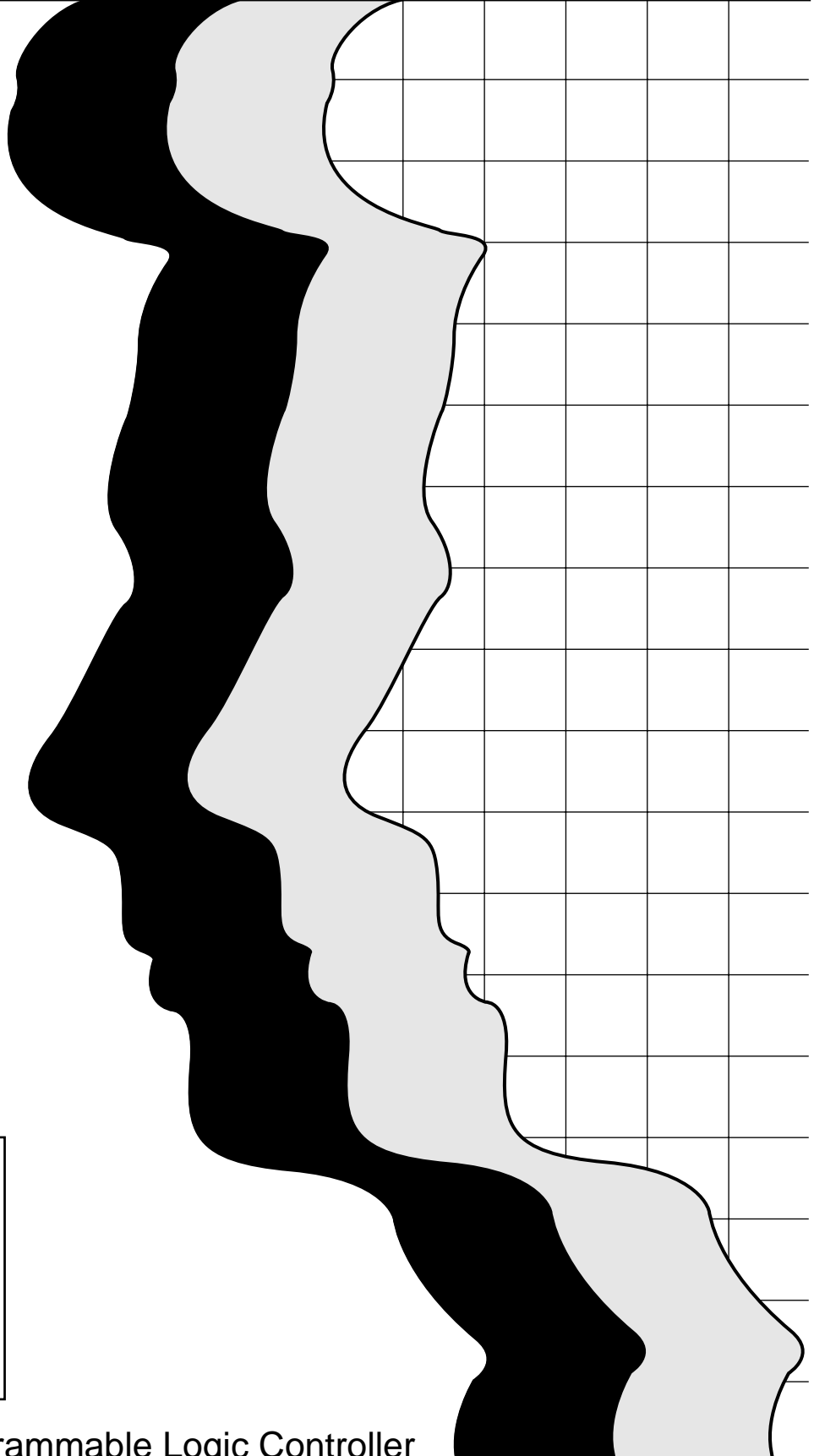



# ● SAFETY PRECAUTIONS ●

(Read these precautions before using.)

When using Mitsubishi equipment, thoroughly read this manual and the associated manuals introduced in this manual.

Also pay careful attention to safety and handle the module properly. These precautions apply only to Mitsubishi equipment. For the safety precautions of the programmable controller system, please read the user's manual of the CPU module to use.

These ● SAFETY PRECAUTIONS ● classify the safety precautions into two categories: "DANGER" and "CAUTION".

 <b>DANGER</b>	<b>Procedures which may lead to a dangerous condition and cause death or serious injury if not carried out properly.</b>
 <b>CAUTION</b>	<b>Procedures which may lead to a dangerous condition and cause superficial to medium injury, or physical damage only, if not carried out properly.</b>

Depending on circumstances, procedures indicated by  CAUTION may also be linked to serious results.

In any case, it is important to follow the directions for usage.

Store this manual in a safe place so that you can take it out and read it whenever necessary. Always forward it to the end user.

## [DESIGN PRECAUTIONS]



### **DANGER**

- Configure a safety circuit external to the PLC, so that the entire system operates safely even if there is an external power error or if the PLC is malfunctioning.
  - (1) The external output are as shown below, depending on the output status setting in the external-output control setting mode:  
Please be careful when performing the setting.  
Refer to the section 3.3.12 about the output status.
  - (2) Due to malfunctions of the output element or its internal circuit, normal output may not be obtained, or erroneous output may be performed.  
For output signals that may cause a severe accident, set an external circuit to monitor the output.

## [DESIGN PRECAUTIONS]



### **CAUTION**

- Do not bundle, or near the control cables and communication cables with the main circuit and power cables. Keep them at least 100mm (3.94 inch) away from such cables. Noise may cause erroneous operation.

## [INSTALLATION PRECAUTIONS]



### **CAUTION**

- Use the PLC in the environment given in the general specifications of this manual. Using the PLC outside the range of the general specifications may result in electric shock, fire or malfunctioning, or may damage or degrade the module.
- Insert the tabs at the bottom of the module into the mounting holes in the base module before installing the module. Tighten the module fixing screws by the specified torque. Improper installation may result in malfunctioning, failure or cause the module to fall out.  
Tightening the screws too far may cause damage to the screw and/or the module, resulting in fall out, short circuit, or malfunctions.
- Do not directly touch the module's conductive parts or electronic components. Doing so could cause malfunction or failure in the module.
- Insert the wire breakage detection connector installation screw into the mounting holes in the module, and after tightening the connector installation screw with specified torque.  
If the connector is not properly installed and tightened, it may result in error detection of wire breakage.

## [WIRING PRECAUTIONS]

### CAUTION

- Be sure to ground the shielded cable.  
Not doing so could result in malfunction.
- When wiring in the PLC, be sure that it is done correctly by checking the product's rated voltage and the terminal layout. Connecting a power supply that is different from the rating or incorrectly wiring the product could result in short circuit or failure.
- Tighten the screws within the range of specified torque.  
If the screws are loose, it may cause the module to fallout, short circuits, or malfunction.  
If the screws are tightened too much, it may cause damage to the screw and/or the module, resulting in fallout, short circuits or malfunction.
- Be sure that cuttings, wire chips, or other foreign matter do not enter the module.  
Foreign matter may start a fire or cause failure or malfunction.
- Be sure to fix communication cables and power cables leading from the module by placing them in the duct or clamping them. Cables not placed in the duct or without clamping may hang or shift, allowing them to be accidentally pulled, which may result in a module malfunction and cable damage.
- When detaching the communication cable from the module, do not pull the cable portion. For cables with connectors, hold the connector at the junction to the module, then detach it. For cables without connectors, first loosen the screw at the junction, then detach the cable.  
Pulling the cable portion while it is connected to the module may cause a malfunction or damage to the module and cable.

## [STARTING AND MAINTENANCE PRECAUTIONS]

### CAUTION

- Do not touch any terminals during power distribution.  
It may cause malfunction.
- Be sure to shut off all phases of the external power supply before cleaning or retightening the terminal screws or module fixing screws. If you do not switch off the external power supply, it will cause failure or malfunction of the module. Tightening the screw too far may cause damage to the screw and/or the module, resulting in fall out, short circuit, or malfunctions.
- Never disassemble or modify the module. This may cause failure, malfunctioning, injury and/or fire.
- Be sure to shut off all phases of the external power supply used by the system before mounting or removing the module. If you do not switch off the external power supply, it will cause electric shock.
- Always make sure to touch the grounded metal to discharge the electricity charged in the body, etc., before touching the module.  
Failure to do so may cause a failure or malfunctions of the module.

**[DISPOSAL PRECAUTIONS]**



**CAUTION**

- When disposing of this product, handle it as industrial waste.

# Revisions

\* The manual number is noted at the lower left of the back cover.

Print Date	*Manual Number	Revision
Aug. 1997	SH (NA)-3643-A	First printing
Sep. 2002	SH (NA)-3643-B	<div style="border: 1px solid black; display: inline-block; padding: 2px;">Correction</div> SAFETY PRECAUTIONS, Section 2.2, 3.1, 3.2.1, 3.2.2, 3.3.1, 3.3.8, 3.3.9, 3.3.11, 3.3.12, 3.5.1, 3.5.2, 3.6.1, 3.6.3, 3.6.10, 3.6.12, 3.6.15, 3.6.16, 3.6.17, 3.6.22, 3.6.24, 3.6.30, 3.6.32, 3.6.35, 3.6.37, 4.2, 5.1, 5.2.1, 6.1, 6.3
Jun. 2003	SH (NA)-3643-C	<div style="border: 1px solid black; display: inline-block; padding: 2px;">Correction</div> <span style="float: right;">6.30</span> SAFETY PRECAUTIONS, Section 3.6.15, 3.6.28
Nov. 2004	SH (NA)-3643-D	<div style="border: 1px solid black; display: inline-block; padding: 2px;">Correction</div> SAFETY PRECAUTIONS, Section Chapter 3.3.1, 3.3.12, 3.6.1, 3.6.4, 5, 5.2.1, WARRANTY
Mar. 2006	SH (NA)-3643-E	<div style="border: 1px solid black; display: inline-block; padding: 2px;">Correction</div> Section 6.7

Japanese Manual Version SH-3646- G

This manual does not imply guarantee or implementation right for industrial ownership or implementation of other rights. Mitsubishi Electric Corporation is not responsible for industrial ownership problems caused by use of the contents of this manual.

# INTRODUCTION

Thank you for choosing a Mitsubishi MELSEC-A Series General Purpose Programmable Controller.

Before using your new PLC, please read this manual thoroughly to gain an understanding of its functions so you can use it properly.

Please forward a copy of this manual to the end user.

## Table of Contents

<b>1</b>	<b>General Description</b>	<b>1- 1 to 1- 10</b>
1.1	Characteristics	1- 3
1.2	Parts Included in the Shipment	1- 4
1.3	The PID Control System	1- 5
1.4	About the PID Operation	1- 6
1.4.1	Operation method and formula	1- 6
1.4.2	Proportional action (P-action)	1- 7
1.4.3	Integral action (I-action)	1- 8
1.4.4	Derivative action (D-action)	1- 9
1.4.5	PID action	1-10
<b>2</b>	<b>System Configuration</b>	<b>2- 1 to 2- 2</b>
2.1	Configuration of the Entire System	2- 1
2.2	Applicable Systems	2- 2
<b>3</b>	<b>Specification</b>	<b>3- 1 to 3-39</b>
3.1	General Specification	3- 1
3.2	Performance Specification	3- 2
3.2.1	A1S62TC performance specification	3- 2
3.2.2	Supported thermocouple types and resolution	3- 4
3.3	Function Summary	3- 5
3.3.1	Auto-tuning function	3- 6
3.3.2	Cooling method setting function	3- 8
3.3.3	Overlap/dead band function	3- 8
3.3.4	RFB limiter function	3- 9
3.3.5	Sensor compensation function	3- 9
3.3.6	Unused channel setting	3- 9
3.3.7	PID output forced stop	3-10
3.3.8	Heater wire breakage detection function (supported only by A1S62TCTTBW-S2)	3-10
3.3.9	Current error detection function when output is off (supported only by A1S62TCTTBW-S2)	3-11
3.3.10	Data storage in E <sup>2</sup> PROM	3-12
3.3.11	Alert alarm	3-13
3.3.12	Settings and control status of the output signals and buffer memory that control the A1S62TC control status	3-17
3.4	Sampling Period and Heating-Cooling Control Output Period	3-18
3.5	I/O Signals for the PLC CPU	3-19
3.5.1	I/O signal list	3-19
3.5.2	Input signal function	3-20
3.5.3	Output signal function	3-23



3.6	Buffer Memory	3-25
3.6.1	Buffer memory list	3-25
3.6.2	Write data error code (buffer memory address: 0H)	3-27
3.6.3	Decimal point position (buffer memory address: 1H, 2H)	3-27
3.6.4	Alert details (buffer memory address: 5H, 6H)	3-28
3.6.5	Temperature process value (PV value, buffer memory address: 9H, AH)	3-28
3.6.6	Heating-cooling manipulated value (MV value, buffer memory address: DH, EH/C0H, C1H)	3-29
3.6.7	Heating-cooling manipulated value (MV value: 0 to 4000; buffer memory address: B1H, B2H/C2H, C3H)	3-29
3.6.8	Temperature increase determination flag (buffer memory address: 11H, 12H)	3-29
3.6.9	Heating-cooling transistor output flag (buffer memory address: 15H, 16H/C4H, C5H)	3-30
3.6.10	Heater current process value (buffer memory address: 19H, 1AH)	3-30
3.6.11	Cooling contact temperature process value (buffer memory address: 1DH)	3-30
3.6.12	Input range (buffer memory address: 20H, 40H)	3-31
3.6.13	Stop mode setting (buffer memory address: 21H, 41H)	3-32
3.6.14	Set value (SV) setting (buffer memory address: 22H, 42H)	3-32
3.6.15	PID constant setting (buffer memory address: 23H to 25H, 43H to 45H, D0H, E0H)	3-32
3.6.16	Alert alarm 1 to 4 setting (buffer memory address: 26H to 29H, 46H to 49H)	3-33
3.6.17	Heating-cooling upper output limiter setting (buffer memory address: 2AH, 4AH/D1H, E1H)	3-33
3.6.18	Sensor compensation value setting (buffer memory address: 2DH, 4DH)	3-33
3.6.19	Heating-cooling control output period setting (buffer memory address: 2FH, 4FH/D2H, E2H)	3-33
3.6.20	Temporary-delay digital filter setting (buffer memory address: 30H, 50H)	3-34
3.6.21	Control response parameter setting (buffer memory address: 31H, 51H)	3-35
3.6.22	Setting variation limiter setting (buffer memory address: 34H, 54H)	3-35
3.6.23	Upper/Lower setting limiter (buffer memory address: 37H, 38H, 57H, 58H)	3-36
3.6.24	CT selection (buffer memory address: 39H, 59H)	3-36
3.6.25	Heater wire breakage alert setting (buffer memory address: 3AH, 5AH)	3-36
3.6.26	Not used channel setting (buffer memory address: 3DH, 5DH)	3-37
3.6.27	Alert alarm 1 to 4 mode setting (buffer memory address: A0H to A3H)	3-37
3.6.28	Alert blind section setting (buffer memory address: A4H)	3-37
3.6.29	Number of alert delays setting (buffer memory address: A5H)	3-37
3.6.30	Number of current detection delays setting when heater is wire breakage/output is off (buffer memory address: A6H)	3-38
3.6.31	Temperature increase completion range setting (buffer memory address: A7H)	3-38
3.6.32	Increased temperature complete soak time setting (buffer memory address: A8H)	3-38
3.6.33	PID continue flag (buffer memory address: A9H)	3-38
3.6.34	Heater voltage compensation function selection (buffer memory address: AAH)	3-38
3.6.35	Standard heater current value (buffer memory address: ABH, ACH)	3-38
3.6.36	Transistor output monitor ON delay time setting (buffer memory address: AFH)	3-39
3.6.37	CT monitor method switch (buffer memory address: B0H)	3-39
3.6.38	Cooling method setting (buffer memory address: CFH)	3-39
3.6.39	Overlap/dead band setting (buffer memory address: D3H, E3H)	3-39

<b>4 Setting and Procedure Before Operation</b>	<b>4- 1 to 4- 6</b>
---	---------------------

4.1	Procedure Before Operation	4- 1
4.2	Precautions when Handling	4- 2
4.3	Name of Each Part	4- 3
4.4	Wiring	4- 4
4.4.1	Precautions when wiring	4- 4
4.4.2	Module wiring example	4- 5

**5 Programming . . . . . 5- 1 to 5- 4**

5.1 Programming Procedure . . . . . 5- 1  
5.2 Program Example . . . . . 5- 2  
5.2.1 Program to perform the initial setting and read temperature-detection value . . . . . 5- 2

**6 Troubleshooting . . . . . 6- 1 to 6- 4**

6.1 Error Code List . . . . . 6- 1  
6.2 The A1S62TC Processing During Error . . . . . 6- 2  
6.3 When the A1S62TC RUN LED Flashes or Turns OFF . . . . . 6- 3  
6.4 When the ALM LED is Turned ON or Flashing . . . . . 6- 3  
6.5 When the Temperature Adjustment Ready Flag (X1) is not Turned ON . . . . . 6- 3  
6.6 When the Write Data Error Flag (X2) is ON . . . . . 6- 4  
6.7 When the H/W (hardware) Error Flag (X3) is ON . . . . . 6- 4  
6.8 When the Alert Flag (XC, XD) is ON . . . . . 6- 4

**Appendix . . . . . Appendix- 1**

Appendix 1 External Dimensions . . . . . Appendix- 1

# 1 General Description

This manual describes the specification, usage, wiring and programming methods of the following heating-cooling temperature control modules used in conjunction with the MELSEC-A series PLC CPU module (abbreviated as PLC CPU from here on):

- A1S62TCTT-S2 Heating-Cooling Temperature Control Module (abbreviated as A1S62TCTT-S2 from here on)
- A1S62TCTTBW-S2 Heating-Cooling Temperature Control Module with Wire Breakage Detection Function (abbreviated as A1S62TCTTBW-S2 from here on)

A1S62TCTT-S2 and A1S62TCTTBW-S2 together are abbreviated as A1S62TC in this manual.

## (1) What is A1S62TCTT-S2?

- The A1S62TCTT-S2 converts the input values from the external temperature sensor (thermocouple) into the 16-bit signed BIN (binary) data. The module aims to adjust temperature by performing the PID operation to reach the target, then performs transistor output.
- The A1S62TCTT-S2 has an auto-tuning function, which automatically sets the proportional band (P), integral time (I), and derivative time (D) to perform PID operations.
- The A1S62TCTT-S2 supports connections with the following thermocouple models: K, J, T, B, S, E, R, N, U, L, PLII and W5Re/W26Re.

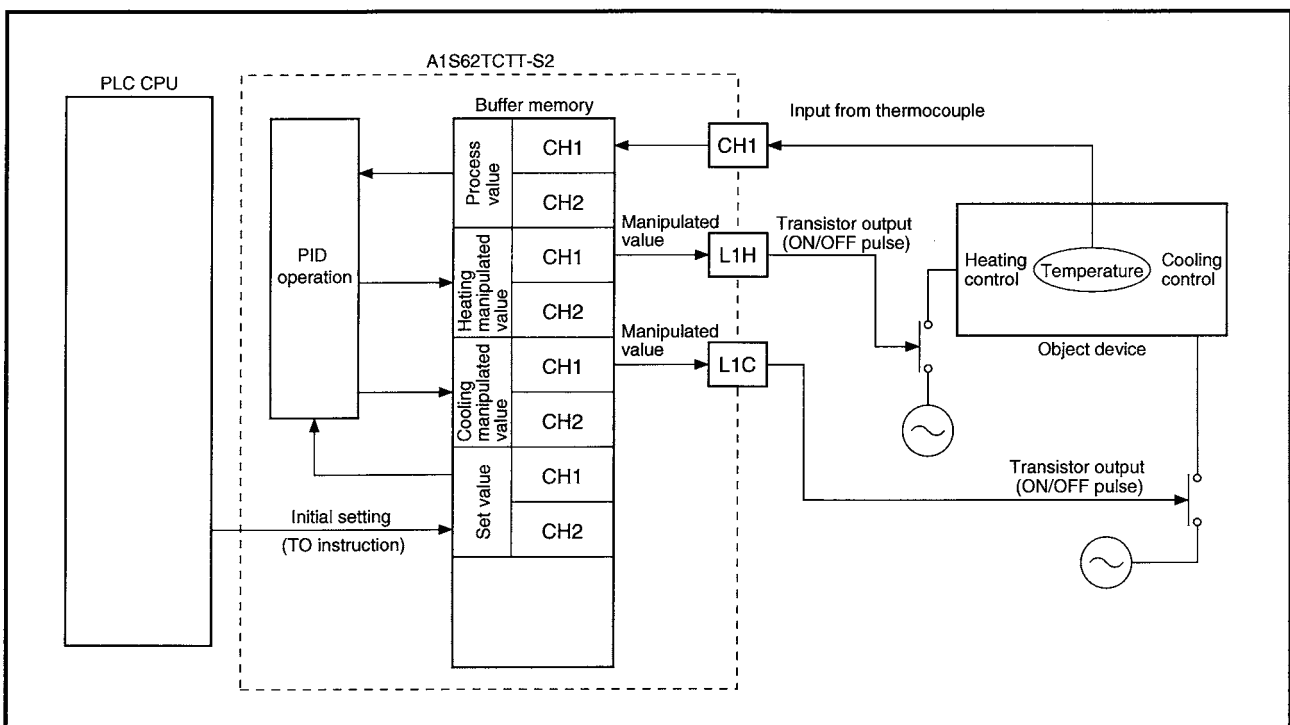

Fig. 1.1 A1S62TCTT-S2 processing overview

### Remarks

- 1) Refer to Section 3.3.1 for the auto-tuning function.
- 2) Refer to Section 3.2.2 for the measurement temperature range of thermocouples that can be connected to the A1S62TC.

(2) What is A1S62TCTTBW-S2?

The A1S62TCTTBW-S2 is a module that externally added a function which enables to detect a heater disconnection using input from the current sensor to the A1S62TCTT-S2.

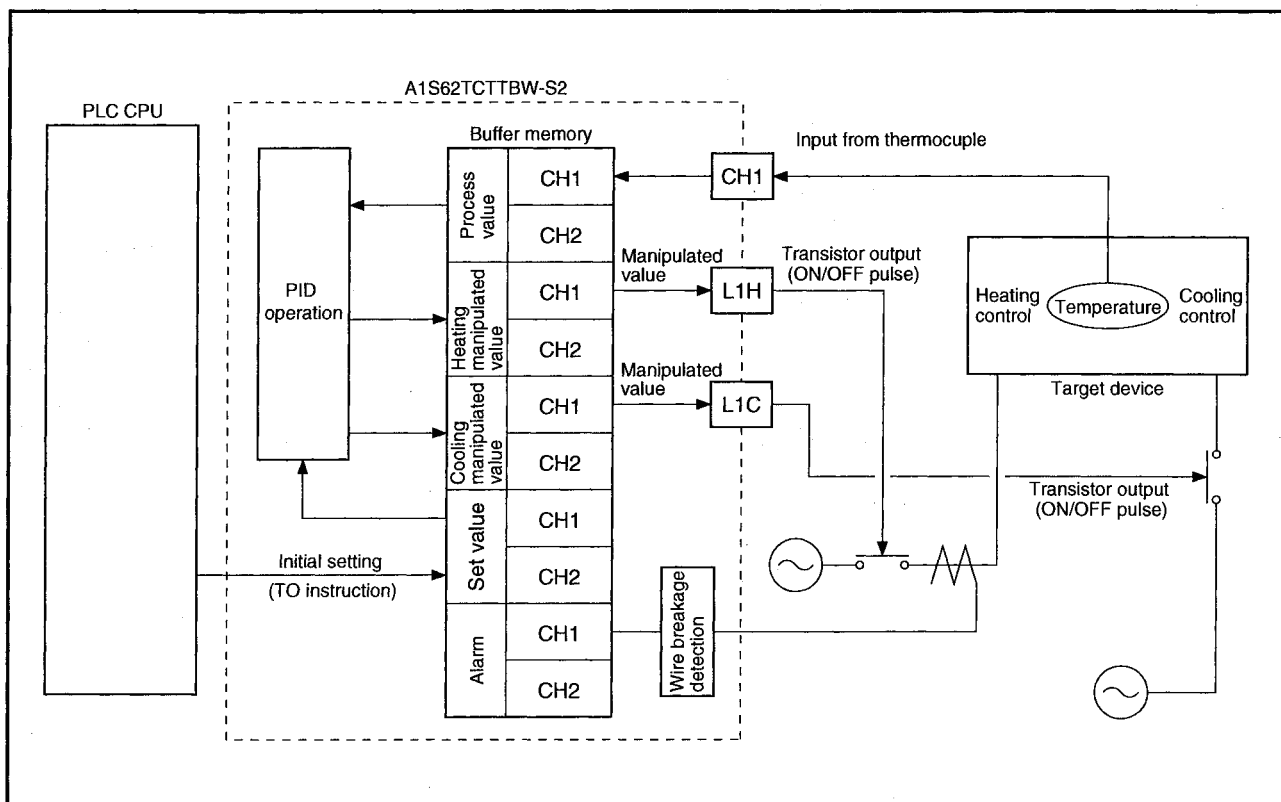

Fig. 1.2 A1S62TCTTBW-S2 processing overview

**Remark**

- 1) Refer to Section 3.3.8 for A1S62TCTTBW-S2's disconnection detection function.

## 1.1 Characteristics

The A1S62TC has the following characteristics:

**(1) Optimal temperature adjustment control (PID control) can be performed.**

- (a) The A1S62TC can perform temperature adjustment control automatically by just setting the PID constants (Proportional band (P), Integral time (I), and Derivative time (D)) and temperature set value (Set value: SV) necessary for PID operations. Therefore, no special instructions are necessary to perform the PID control.
- (b) If the auto-tuning function is used, the A1S62TC can set the PID constants automatically. Therefore, the system can be used without being preoccupied about performing cumbersome PID operation expressions to obtain the PID constants.

**(2) Double loop in one module**

Two channels of platinum temperature-measuring resistor input and transistor output circuit are internally equipped, enabling simultaneous temperature adjustment control in two loops.

**(3) Heating and cooling PID control is feasible.**

Having two PID outputs, namely, heating and cooling, for one sensor input enables temperature adjustment of controlled object that generates heat by itself at high stability.

**(4) RFB limiter function**

The RFB (Reset feed back) limiter suppresses overshoots, which tend to occur at the startup and when the temperature set value (SV) is raised.

**(5) Sensor compensation function**

When there is a difference between the process value (PV) and the temperature set value (SV), the difference can be eliminated by setting the sensor compensation value.

**(6) Supports thermocouple connections conforming to the JIS, IEC, NBS ASTM and DIN standards.**

- (a) The following thermocouples which conform to the JIS, IEC, NBS, ASTM or DIN standards can be connected to the A1S62TC:
- JIS standard: R, K, J, S, B, E, T
  - IEC standard: R, K, J, S, B, E, T, N
  - NBS standard: PLII
  - ASTM standard: W5Re/W26Re
  - DIN standard: U, L
- (b) The A1S62TC can set a temperature measurement range depending on the operation temperature for each of the above thermocouples.

**(7) Selectable from fine temperature measurement units and various control temperature ranges**

The temperature measurement unit of each group can be set to 1°C or 0.1°C in Centigrade, and 1°F or 0.1°F in Fahrenheit. Therefore, a suitable resolution can be selected for the control. In addition, the controllable temperature range can be selected from 56 kinds such as; 0.0 to 400.0°C (when K-type thermocouple is used), 0.0 to 3000.0°C (when R-type thermocouple is used), enabling a setting most suitable for the controlling object.

**(8) Backup of the set value to E<sup>2</sup>PROM**

The set values in the buffer memory can be stored in E<sup>2</sup>PROM as backup.

If the data is written directly into the buffer memory using the test function of the GPP, the sequence program in the PLC CPU can be minimized "LD\*\*\* + "OUT Y11".

**(9) Wire breakage detection function is supported.**

When using the A1S62TCTTBW-S2 the heater wire breakage can be detected.

## 1.2 Parts Included in the Shipment

Table 1.1 shows the parts that are included in the A1S62TC shipment.

The parts shown in the Table 1.1 are included in the same package or are pre-installed to the A1S62TC when shipped.

- Refer to Section 4.4.2 for wiring of the wire breakage detection connector.

**Table 1.1 Parts Included in the Shipment**

Item	A1S62TCTT-S2	A1S62TCTTBW-S2
Wire breakage detection connector	—	1

### 1.3 The PID Control System

(1) The PID control system

Figure 1.3 indicates the system configuration when performing PID control.

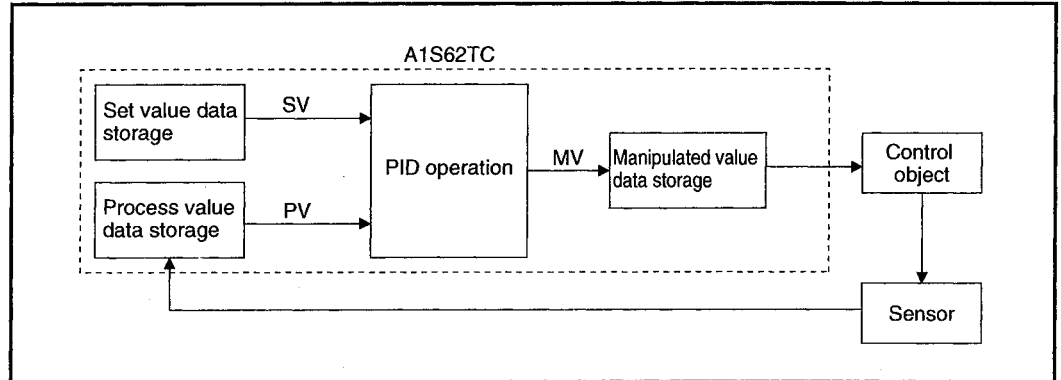

Fig. 1.3 The PID control system

(2) PID control procedure

The PID control is performed in the procedure shown in Figure 1.4 below:

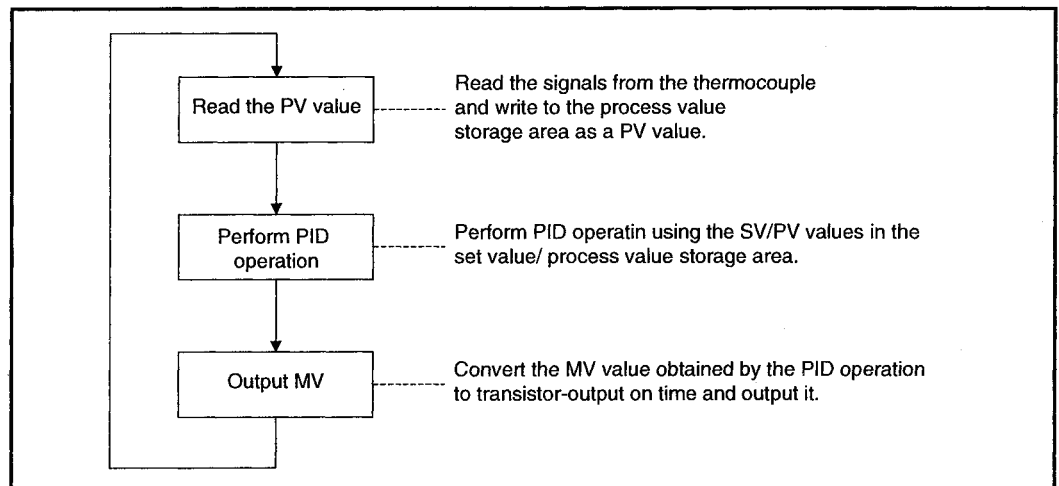

Fig. 1.4 PID control procedure

(3) PID control (simplified two-level response selection)

In general, when the P, I, and D constants to improve the "response to the setting" are set, the "response to the disturbance" degrades by the PID control.

Conversely, when the P, I, and D constants to improve the "response to the disturbance" are set, the "response to the setting" degrades by the PID control.

In the PID control (simplified two-level response selection) of this module, "fast", "normal", or "slow" can be selected for the "response to the setting" while the P, I, and D constants for better "response for the disturbance" are selected.

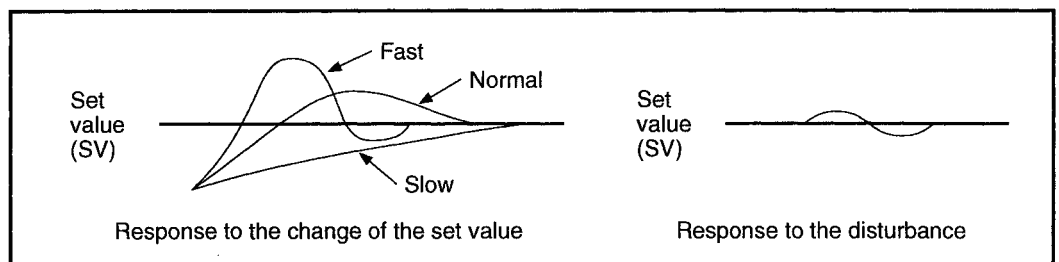

Fig. 1.5 Simplified two-level response selection

## 1.4 About the PID Operation

The A1S62TC can perform PID control in process-value incomplete differentiation.

### 1.4.1 Operation method and formula

The PID control in process-value incomplete differentiation is an operation method which puts the first-order delay filter as the input for derivative control action, and performs PID operation with the error value (E) after deleting the high-frequency noise component.

(1) The algorithm of the PID control in process-value incomplete differentiation is shown in Figure 1.6.

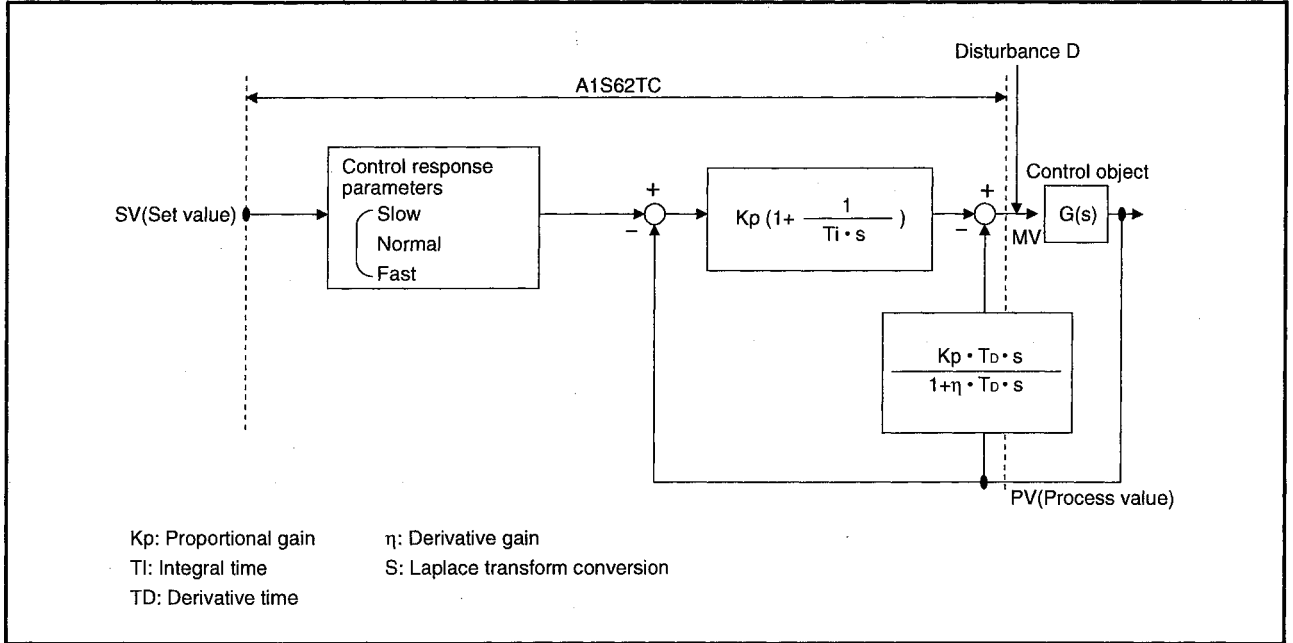

Fig. 1.6 Algorithm of PID control in process-value incomplete differentiation

(2) The formula used for A1S62TC is shown below:

$$MV_n = MV_{n-1} + \frac{T_D}{\tau + \eta \cdot T_D} \left\{ (PV_{n-1} - PV_n) - \frac{\tau}{T_D} \cdot MV_{n-1} \right\}$$

- τ : Sampling period
- MV : Incomplete derivative output
- PV : Process value
- T<sub>D</sub> : Derivative time
- η : Derivative gain



### 1.4.2 Proportional action (P-action)

- (1) The proportional action is an action to obtain the manipulated value proportional to the deviation (difference between set value and process value).
- (2) With the proportional action, the relationship between the changes in the deviation and manipulated value can be expressed in the following formula:

$$MV = K_p \cdot E$$

where  $K_p$  is a proportional constant and is called the proportional gain.

- (3) The proportional action for the step response when the error value is constant is shown in Figure 1.7.
- (4) The manipulated value changes between -5.0% and 105.0%. As the  $K_p$  increases, the manipulated value for the same error value becomes larger, and the corrective action becomes stronger.
- (5) The proportional action will generate an offset (remaining deflection).

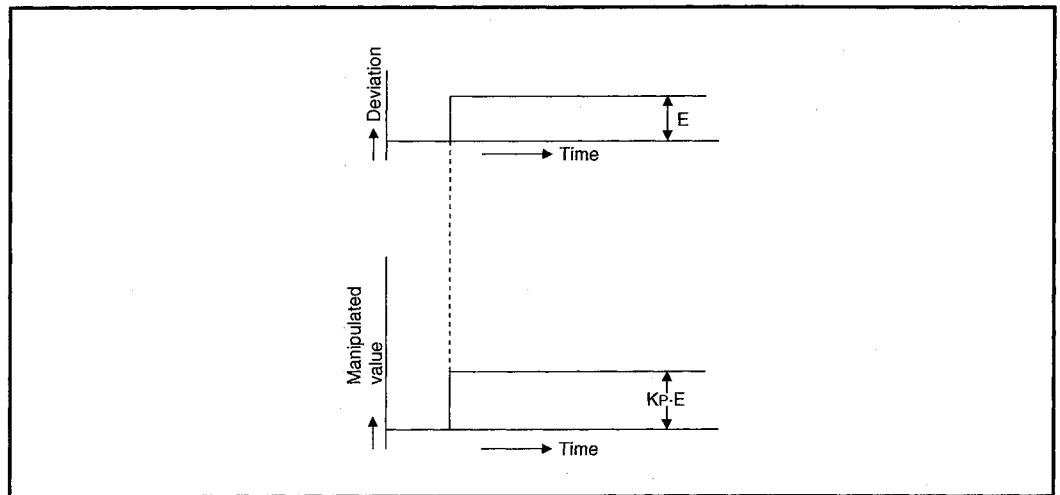

Fig. 1.7 Proportional action for step response

### 1.4.3 Integral action (I-action)

- (1) The integral action is an action which continuously changes the manipulated value to eliminate the deviation when there is an deviation.  
The offset produced by the proportional action can be eliminated.
- (2) In the integral action, the time from the deviation occurrence until the manipulated value of the integral action becomes that of the proportional control action is called the integral time, and is indicated by  $T_i$ .
- (3) The integral action for the step response when the error value is constant is shown in Figure 1.8.
- (4) The integral action is used as a PI action in combination with the proportional action, or PID action in combination with the proportional and derivative actions.  
The integral action cannot be used alone.

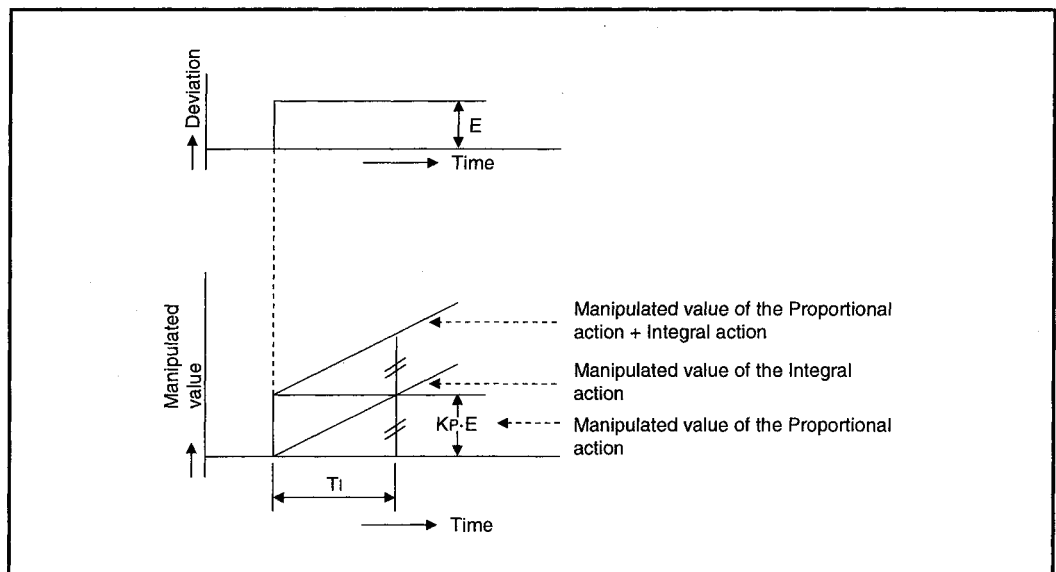

Fig. 1.8 Integral action for step response

### 1.4.4 Derivative action (D-action)

- (1) The derivative action adds the manipulated value proportional to the change speed to eliminate error when an deviation occurs.  
The derivative control action can prevent the control target from changing significantly due to disturbance.
- (2) In the derivative action, the time from the deviation occurrence until the manipulated value of the derivative action becomes that of the proportional action is called the derivative time, and is indicated by  $T_D$ .
- (3) The derivative action for the step response when the deviation is constant is shown in Figure 1.9.
- (4) The derivative action is used as a PD action in combination with the proportional action, or PID action in combination with the proportional and integral actions.  
The derivative action cannot be used alone.

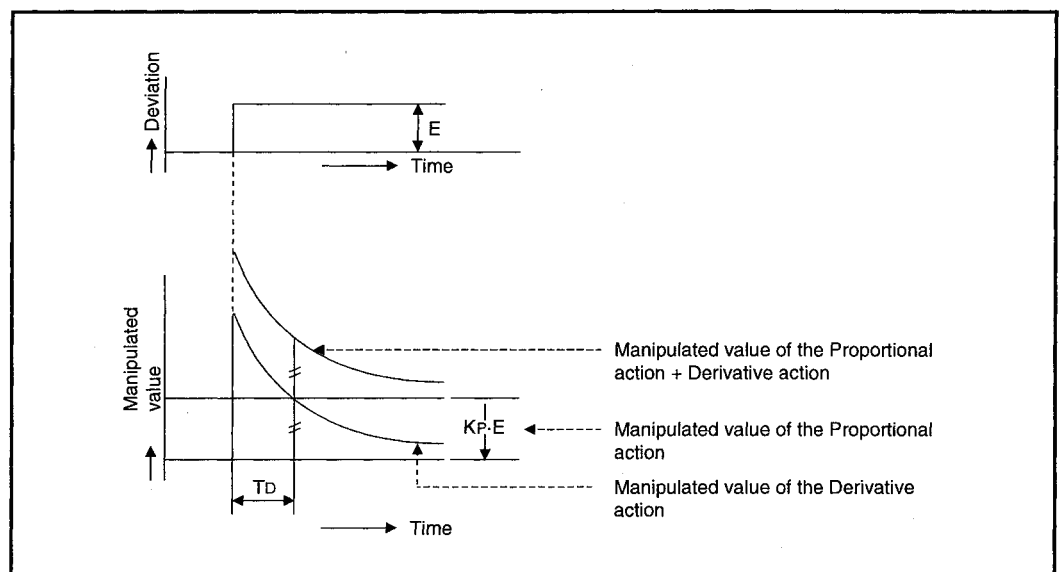

Fig. 1.9 Derivative action for step response

**1.4.5 PID action**

- (1) The PID action performs control using the manipulated value obtained by merging proportional action, integral action and derivative action.
- (2) The PID action for the step response when the deviation is constant is shown in Figure 1.10.

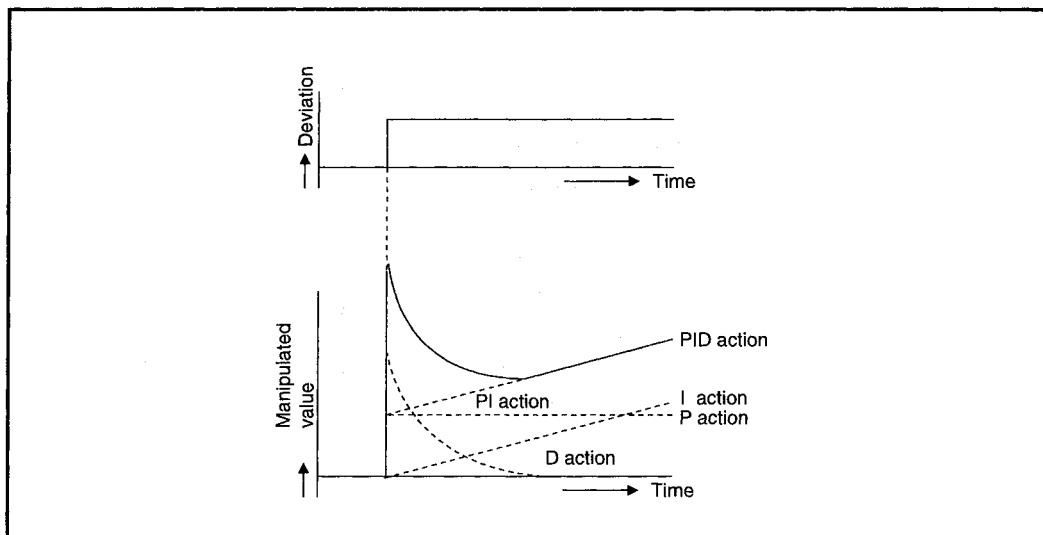
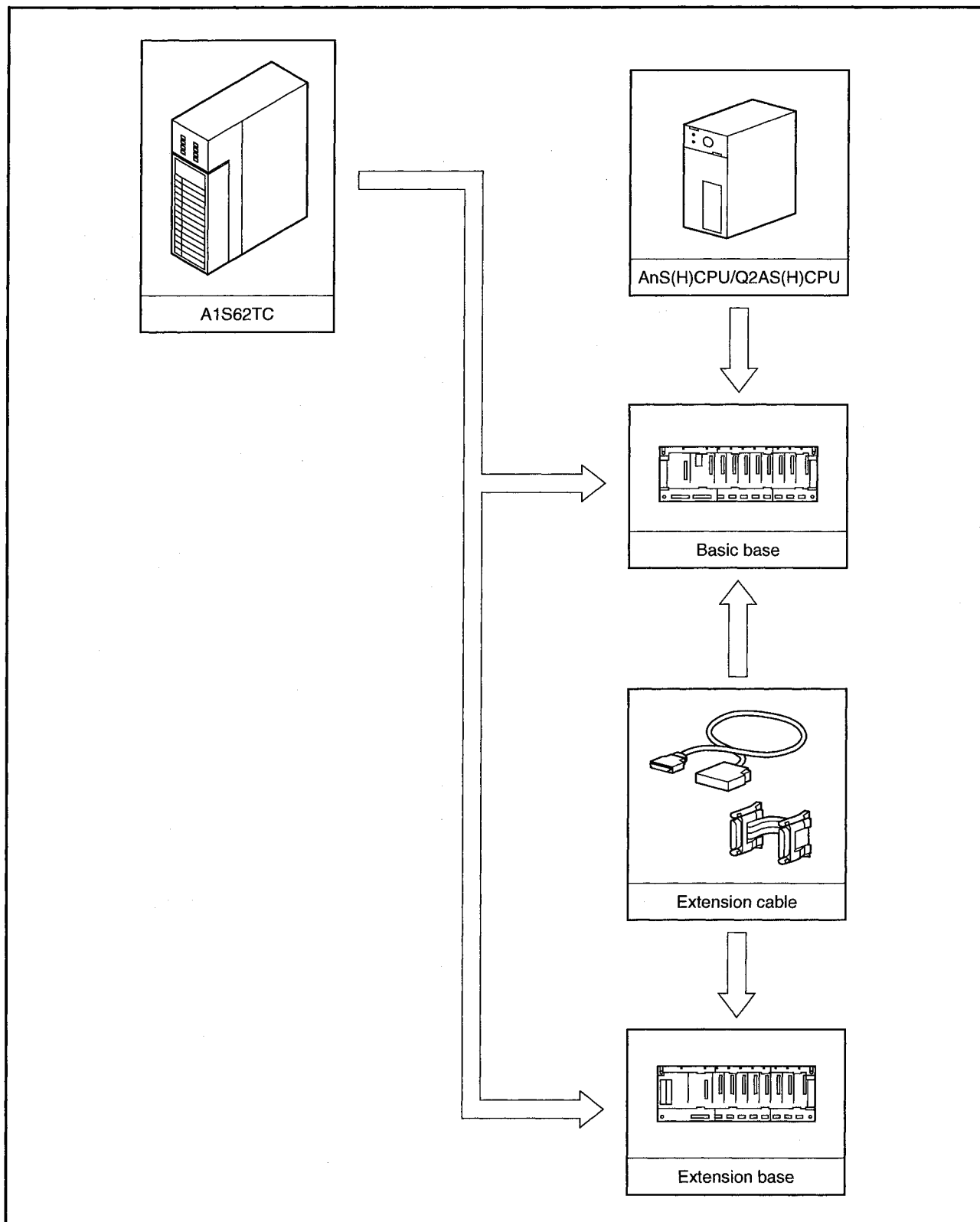

Fig. 1.10 PID action for step response

## 2 System Configuration

### 2.1 Configuration of the Entire System

The configuration of the entire system with the A1S62TC is shown below:



## 2.2 Applicable Systems

The A1S62TC can be applied to the following CPU modules:

Applicable device models	A1SJCPU (S3)	A2SCPU	A52GCPU
	A1SJHCPU	A2SHCPU	Q02CPU-A
	A1SCPU	A2USCPU (S1)	Q02HCPU-A
	A1SCPUC24-R2	A2USHCPU-S1	Q06HCPU-A
	A1SHCPU	Q2ASCPU (S1)	
		Q2ASHCPU (S1)	

The A1S62TC can be installed to any slots in the base unit except for under the following conditions, and the number of installable modules is unlimited.

- (1) When the A1S62TC is installed on the extension base unit without a power module (A1S52B or A1S55BA1S58B extension base unit), the power capacity may not be sufficient.

When installing on one of these module, consider the following carefully and select a right power supply module, main/extension base unit and extension cable:

- 1) Capacity of the power supply module on the main base unit
- 2) Voltage drop in main base unit
- 3) Voltage drop in the extension base unit
- 4) Voltage drop in the extension cable

- (2) When used for a data link system, the module can be installed to any of the master, local and remote I/O stations.

**Remark**

Refer to the CPU User's manuals for the calculation methods of the I/O point range and voltage drop:

- A1SJCPU (S3) User's Manual..... IB-66446
- A1S/A1SC24-R2/A2SCPU (S1) User's Manual..... IB-66320
- A2ASCPU (S1) User's Maunal..... IB-66455
- A1SJH/A1SH/A2SHCPU (S1) User's Maunal..... IB-66779
- Q2AS (H) CPU (S1) User's Maunal..... SH-3599

## 3 Specification

This chapter describes the general specification, performance specification, I/O signal summary for the PLC CPU, and buffer memory specification.

### 3.1 General Specification

The general specification of the A1S62TC is shown in Table 3.1.

**Table 3.1 General specification**

Item	Specifications					
Operating ambient temperature	0 to 55°C					
Storage ambient temperature	-20 to 75°C					
Operating ambient humidity	10 to 90% RH, Non-condensing					
Storage ambient humidity	10 to 90% RH, Non-condensing					
Vibration resistance	Conforming to JIS B 3502, IEC 61131-2	Under intermittent vibration	Frequency	Acceleration	Amplitude	Sweep count  10 times each in X, Y, Z directions (for 80 min.)
			10 to 57Hz	—	0.075mm (0.003inch)	
		57 to 150Hz	9.8m/s <sup>2</sup>	—		
		Under continuous vibration	10 to 57Hz	—	0.035mm (0.001inch)	
57 to 150Hz	4.9m/s <sup>2</sup>		—			
Shock resistance	Conforming to JIS B 3502, IEC 61131-2 (147m/s <sup>2</sup> , 3 times in each of 3 directions X, Y, Z)					
Operating ambience	No corrosive gases					
Operating attitude	2000m (6562 feet) max.					
Installation area	Inside control panel					
Over voltage category *1	II max.					
Pollution level *2	2 max.					

\*1: This indicates the section of the power supply to which the equipment is assumed to be connected between the public electrical power distribution network and the machinery within the premises. Category II applies to equipment for which electrical power is supplied from fixed facilities. The surge voltage withstand level for up to the rated voltage of 300V is 2500V.

\*2: This index indicates the degree to which conductive material is generated in terms of the environment in which the equipment is used. Pollution level 2 is when only non-conductive pollution occurs. A temporary conductivity caused by condensation must be expected occasionally.

\*3: Do not use or store the PLC under pressure higher than the atmospheric pressure of altitude 0m. Doing so can cause a malfunction.  
When using the PLC under pressure, please contact your sales representative.

## 3.2 Performance Specification

### 3.2.1 A1S62TC performance specification

Table 3.2 A1S62TC performance specification summary

		Specification	
		A1S62TCTT-S2	A1S62TCTTBW-S2
Control output		Transistor output	
Temperature input points		2-channel/module	
Supported thermocouple		See Table 3.3.	
Accuracy *1	Indication accuracy	Ambient temperature: 23°C ±5°C	Full-scale x (±0.3%) ±1 digit <sup>2</sup>
		Ambient temperature: 0°C to 55°C	Full-scale x (±0.7%) ±1 digit <sup>2</sup>
	Cold junction temperature compensation accuracy (Ambient temperature 0 to 55°C)	Temperature measurement value: -100°C or more	Within ±1.0°C
		Temperature measurement value: -150°C to -100°C	Within ±2.0°C
		Temperature measurement value: -200°C to -150°C	Within ±3.0°C
Sampling period		0.5s/2-channel (It is not connected with the number of channels used)	
Heating control output period		1 to 100s	
Cooling control output period			
External resistor effects		0.35μV/Ω	
Input impedance		1MΩ	
Input filter		1 to 100s (0: input filter off)	
Sensor compensation value setting		-50.00 to 50.00%	
Action when sensor input is disconnected		Upscale processing	
Temperature control method		PID on/off pulse	
PID constant range	PID constant setting		Auto-tuning setting is possible
	Heating proportional band (Ph)		0.1 to 1000.0%
	Cooling proportional band (Pc)		
	Integral time (I)		1 to 3600s
	Derivative time (D)		0 to 3600s (0: PI control)
Set value setting range		Within the temperature range set by the thermocouple to be used.	
Cooling method setting		Air cooling/water cooling	
Transistor output	Output signal		ON/OFF pulse
	Rated load voltage		10.2 to 30.0VDC (peak voltage: 30.0V)
	Maximum load current		0.1 A/point      0.4 A/common
	Maximum inrush current		0.4 A 10 ms
	Maximum current when OFF		Less than 0.1 mA
	Maximum voltage drop when ON		1.0VDC (TYP) 0.1A      2.5VDC (MAX) 0.1A
	Response time		OFF→ON : Less than 2 ms ON→OFF: Less than 2 ms
Insulation method		Between the input and grounding : transformer insulation Between the input and channel: transformer insulation	
Heater wire breakage detection specification	Current sensor		See section 3.6.24
	Input method		Multiplexor method A/D conversion
	Number of alert delays		3 to 255
Occupied input points		32 points (I/O allocation: special 32 points)	
Connection terminal		20-point terminal block	
Supported cable size		0.75 to 1.5 mm	



	Specification	
	A1S62TCTT-S2	A1S62TCTTBW-S2
Supported solderless terminal	R1.25-3, 1.25-YS3, RAV1.25-3, V1.25-YS3A	
Internal consumed current	0.19 A	0.28 A
Weight	0.25 kg	0.28 kg

\*1: The accuracy is calculated using the following formula:

(Accuracy) = (Specified accuracy) + (Cold-junction temperature compensation accuracy)

Example) Accuracy when the input range setting is "38 (Thermocouple K: -200.0 through 400.0, 0.1°C increment)," operating ambient temperature is 35°C, and the temperature measurement value is 300°C.

{400.0 - (-200.0)} [Full scale] x (±0.007) [±0.7%] + (±0.1°C) [±1 digit] + (±1.0°C) [Cold-junction temperature compensation accuracy] = ±5.3°C

\*2: "±1 digit" will differ depending on the input range used.

If the setting unit is 1°C, "±1 digit" is "±1°C." If the setting unit is 0.1°C, "±1 digit" is "±0.1°C."

For the noise resistance, dielectric withstand voltage, and insulation resistance for the PLC system which uses this module, refer to the power module specification found in the CPU Module User's Manual.

#### **Remark**

If temperature control is conducted by this module using only heating control or cooling control, then the required time for temperature control may be longer than the required time for the temperature control using the following module.

When conducting temperature control using only heating control or cooling control, use the following module.

A1S64TCTT-S1 Temperature Control Module

A1S64TCTTBW-S1 Temperature Control Module with Wire Breakage Detection Function

**3.2.2 Supported thermocouple types and resolution**

Table 3.3 Supported thermocouple types and resolution summary

Thermocouple type	°C		°F	
	Measurement temperature range	Data resolution	Measurement temperature range	Data resolution
R	0 to 1700	1	0 to 3000	1
K	0 to 500 0 to 800 0 to 1300	1	0 to 1000 0 to 2400	1
	-200.0 to 400.0 0.0 to 400.0 0.0 to 500.0 0.0 to 800.0	0.1	0.0 to 1000.0	0.1
J	0 to 500 0 to 800 0 to 1200	1	0 to 1000 0 to 1600 0 to 2100	1
	0.0 to 400.0 0.0 to 500.0 0.0 to 800.0	0.1	0.0 to 1000.0	0.1
T	-200 to 400 -200 to 200 0 to 200 0 to 400	1	0 to 700 -300 to 400	1
	-200.0 to 400.0 0.0 to 400.0	0.1	0.0 to 700.0	0.1
S	0 to 1700	1	0 to 3000	1
B	400 to 1800	1	800 to 3000	1
E	0 to 400 0 to 1000	1	0 to 1800	1
	0.0 to 700.0	0.1		
N	0 to 1300	1	0 to 2300	1
U	0 to 400 -200 to 200	1	0 to 700 -300 to 400	1
	0.0 to 600.0	0.1		
L	0 to 400 0 to 900	1	0 to 800 0 to 1600	1
	0.0 to 400.0 0.0 to 900.0	0.1		
PLII	0 to 1200	1	0 to 2300	1
W5Re/W26Re	0 to 2300	1	0 to 3000	1

### 3.3 Function Summary

The A1S62TC function summary is shown in Table 3.4.

**Table 3.4 A1S62TC function summary**

Item	Specification	Reference
Auto-tuning function	<ul style="list-style-type: none"> <li>The temperature control module automatically sets the optimal PID constants.</li> </ul>	3.3.1
Cooling method setting function	<ul style="list-style-type: none"> <li>Set auto-tuning computation formula corresponding to the cooling performance of each cooling method (water or air cooling).</li> </ul>	3.3.2
Overlap/dead band function	<ul style="list-style-type: none"> <li>Set an overlap, an area in which both heating and cooling are output near the heating/cooling output switchover temperature, or a dead band, where neither of them are output, for the heating/cooling control.</li> </ul>	3.3.3
RFB limiter function	<ul style="list-style-type: none"> <li>Limit the manipulation value overshoot which frequently occurs when the set value (SV) is changed or control target is changed.</li> </ul>	3.3.4
Sensor compensation function	<ul style="list-style-type: none"> <li>Reduces the difference between the measured value and actual temperature to zero when these two are different due to measurement conditions, etc.</li> </ul>	3.3.5
Unused channel setting	<ul style="list-style-type: none"> <li>Sets the PID operation for channels that do not perform temperature adjustment to "not execute."</li> </ul>	3.3.6
PID output forced stop	<ul style="list-style-type: none"> <li>Stops the PID operation for channels that is performing temperature adjustment.</li> </ul>	3.3.7
Heater wire breakage detection function	<ul style="list-style-type: none"> <li>Measures the current that flows in the heater main circuit and detects wire breakage when A1S62TCTTBW-S2 is used.</li> </ul>	3.3.8
Current error detection function when output is off	<ul style="list-style-type: none"> <li>When the A1S62TCTTBW-S2 is used, this function measures the current in the heater's main circuit while the transistor's output is off, and checks if there is a current error when output is off.</li> </ul>	3.3.9
Data storage in E <sup>2</sup> PROM	<ul style="list-style-type: none"> <li>By backing up the buffer memory contents to E<sup>2</sup>PROM, the load of sequence program can be reduced.</li> </ul>	3.3.10
Alert alarm	<ul style="list-style-type: none"> <li>Monitors the process value (PV) and alerts the user.</li> </ul>	3.3.11
A1S62C control status	<ul style="list-style-type: none"> <li>The A1S62TC can be controlled by the output signal of A1S62TC and the settings in the buffer memory.</li> </ul>	3.3.12

### 3.3.1 Auto-tuning function

#### (1) About auto-tuning function

- (a) It is a function which automatically sets optimal PID constants for A1S62TC.

The auto-tuning function computes the PID constants based on the hunting cycles and amplitudes observed while performing the on/off operation of the manipulated value repeatedly in order to overshoot and undershoot the set value.

- (b) The auto-tuning function may be implemented if the data shown below are set.

Before implementing the function, however, set all the other data for actual operation, as actual control operation will be automatically initiated at the completion of auto-tuning.

Name of buffer memory address	Address (hexadecimal)	
	CH.1	CH.2
Input range	20H	40H
Set value (SV) setting	22H	42H
Sensor compensation value setting	2DH	4DH
Heating control output cycle setting	2FH	4FH
First-order delay digital filter setting	30H	50H
Cooling method setting	CFH	
Cooling control output cycle setting	D2H	E2H

- (c) The following constants will be set when auto-tuning is executed:

Name of buffer memory address	Address (hexadecimal)	
	CH.1	CH.2
Heating proportional band (Ph) setting	23H	43H
Cooling proportional band (Pc) setting	D0H	E0H
Integral time (I) setting	24H	44H
Derivative time (D) setting	25H	45H

#### (2) Executing auto-tuning

- (a) Conditions for starting auto-tuning

When any of the following conditions is met, the auto-tuning is not executable.

At this time, the auto-tuning status flag (X4, X5) turns OFF from ON. However, because the auto-tuning is not complete, PID constants and the open-loop detection time are not changed.

- 1) The module is in the setting mode (Y11:OFF).
- 2) In the Unused channel setting (buffer memory address: 3DH, 5DH), 1 (Unused) is set for the channel.
- 3) The PID output forced stop command (Y1A, Y1B) is ON.
- 4) Hardware failure is identified (The "RUN" LED flashes at 1s intervals).
- 5) The measured temperature value (PV) (buffer memory address: 9H, AH) is outside the temperature measurement range (Refer to Section 3.6.4.)

(b) Auto-tuning is performed in the following procedure:

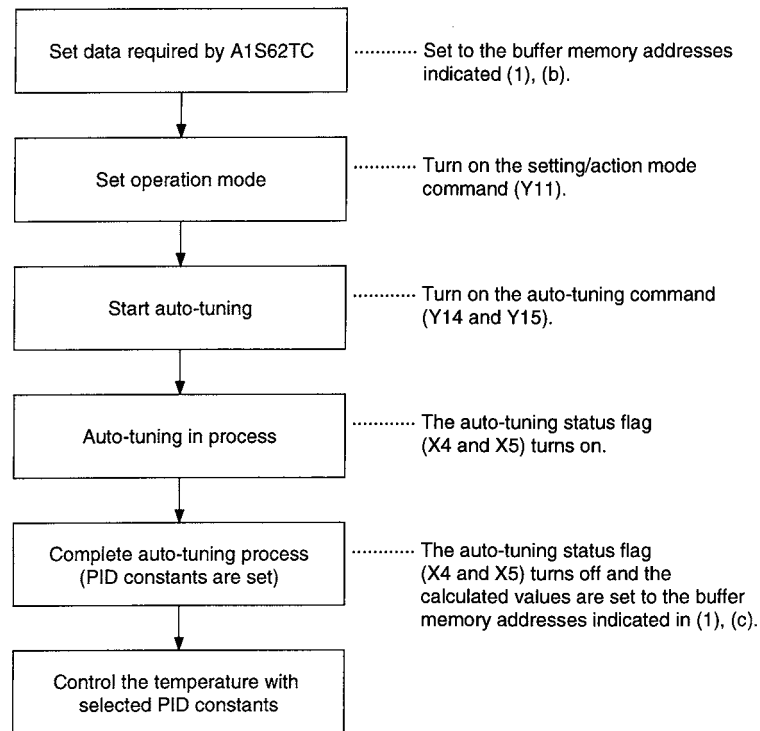

(c) Auto-tuning operation

The following describes the auto-tuning operation:

- 1) Start auto-tuning output.
- 2) Data acquisition begins when the process value drops to the set value after the initial overshoot.
- 3) Following the data acquisition, the PID constants are set, and auto-tuning is completed.

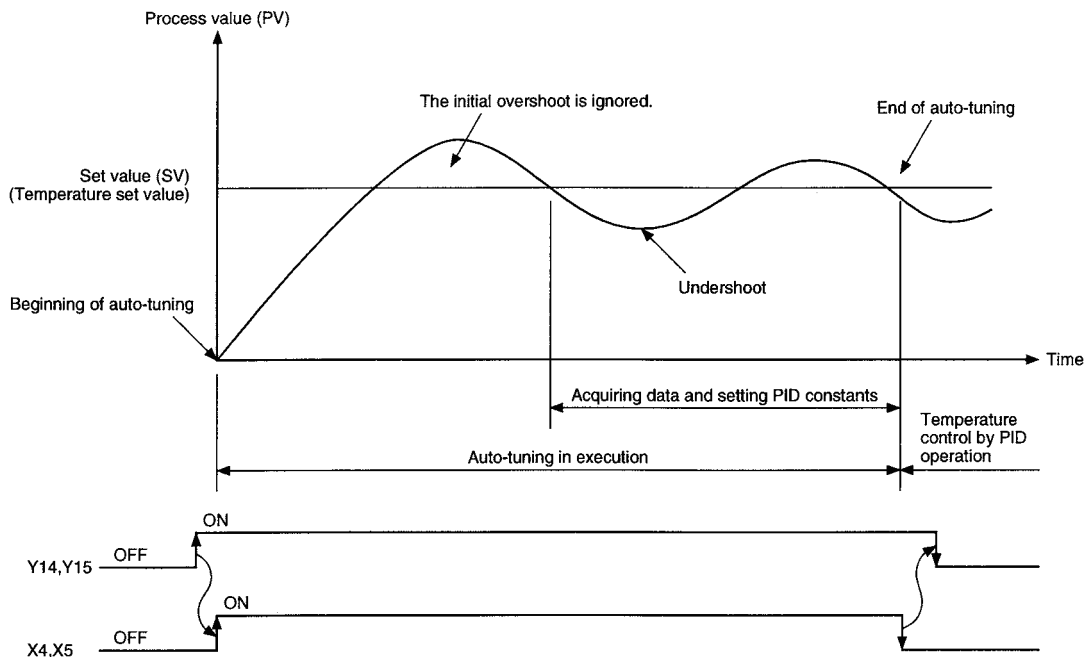

## (d) Precautions for auto-tuning

When any of the following conditions is met, the auto-tuning is terminated unsuccessfully.

At this time, the auto-tuning status flag (X4, X5) turns OFF from ON. However, because the auto-tuning is unsuccessfully terminated, PID constants and the open-loop detection time are not changed.

- 1) The setting/operation mode command(Y11) was turned off. (Except when the PID continuation flag (buffer memory address: A9H) is "Continue")
- 2) Any of the following setting items for the channel has been changed during execution of the auto-tuning.

Setting item	Buffer memory address (Hexadecimal)	
	CH1	CH2
Set value (SV) setting	22H	42H
Heating-cooling upper output limiter	2AH	4AH
Sensor compensation value setting	2DH	4DH
First-order delay digital filter setting	30H	50H
Unused channel setting	3DH	5DH

- 3) The measured temperature value (PV) (buffer memory address: 9H, AH) exceeds the temperature measurement range (refer to section 3.6.4).
- 4) The PID output forced stop command (Y1A, Y1B) has been turned ON.
- 5) A hardware error has occurred.
- 6) The upper setting limiter (buffer memory address: 37H, 57H), or the lower setting limiter (buffer memory address: 38H, 58H) has been changed and thereby the set value (SV) is outside the setting range.

**(3) Operation at termination of auto tuning**

## (a) Operation at normal termination

- The auto-tuning status flag (X4, X5) turns off.
- The PID constants are set.

## (b) Operation at abnormal termination

- The auto-tuning status flag (X4, X5) turns off.
- The PID constants are not set.

**(4) Making additional adjustments after auto-tuning**

## (a) No adjustments are required for the PID constants once computed through auto-tuning.

## (b) To modify the control response, which are based on the PID constants obtained from the auto-tuning, vary the control-response parameters (buffer memory address: 31H and 51H).

**Remark**

- 1) The length of time required to complete auto-tuning depends on the control target.
- 2) The completion of auto-tuning may be confirmed by the "auto-tuning in process" flag (X4 and X5) going from on to off.
- 3) The PID constants computed in auto-tuning may be backed up to E<sup>2</sup>PROM. (Refer to Section 3.3.10.)

### 3.3.2 Cooling method setting function

#### (1) Cooling method setting function

In general, water cooling is more efficient than air cooling. If the same PID constant as air cooling is used for water cooling, it prolongs the stabilization time at initial startup, disturbance and setting modifications. Therefore, in auto-tuning, greater PID constant is obtained for water cooling setting than air cooling.

#### (2) Cooling method setting

Set the buffer memory for cooling method setting to "0" for air cooling and "1" for water cooling. (buffer memory address: CFH)

However, set to water cooling even if air cooling is used when the cooling effect is too high, and set to air cooling even if water cooling is used when the cooling performance is not sufficient.

### 3.3.3 Overlap/dead band function

#### (1) About the overlap and dead band

In heating/cooling control, when the self heat generation of the control object and natural cooling is well balanced, a slight control output of heating or cooling may dramatically change the process value (PV), resulting in excessive output. By setting overlap and dead band, the temperature to resume cooling control output can be shifted to either control stability or save energy direction.

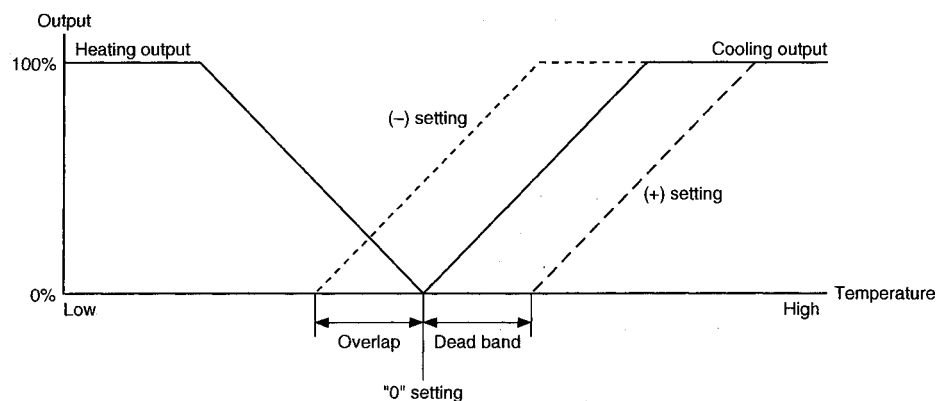

#### (2) Overlap setting

In overlap, there is a temperature range where both heating and cooling are output. The heating ability and cooling ability cancel each other out in the area and the control gain becomes moderate. Thus, variation of process value (PV) for the output is minimized and the control stability can be improved.

To set overlap, set a full-scale input range percentage (-10.0% to -0.1%) into the buffer memory (CFH).

#### (3) Dead band setting

In dead band, there is a temperature range where neither heating or cooling is output. If the process value (PV) is stabilized in this temperature range, output will not be performed for a little change of temperature, resulting in saving energy.

To set dead band, set a full-scale input range percentage (0.1% to 10.0%) into the buffer memory (CFH).

### 3.3.4 RFB limiter function

---

#### (1) RFB (Reset feed back) limiter function

The RFB limiter function limits the PID operation result (manipulated value: MV) not to exceed the valid range by the integral control action when an error continues for a long time.

With the RFB limiter function, if the PID operation result exceeds the upper output limiter value, the amount exceeded is fed back to the integral value and the PID operation result is kept at the limit value.

### 3.3.5 Sensor compensation function

---

#### (1) Sensor compensation function

The sensor compensation function compensates the difference between the measured temperature and actual temperature caused by measurement conditions.

#### (2) Sensor compensation value setting

When there is a difference between the measured temperature and actual temperature, the full-scale percentage of the input range (-50.00 to 50.00%) is set in the buffer memory for sensor compensation value setting (2DH and 4DH) as the sensor compensation value.

Example: The input range is set between -200°C and 200°C. The process temperature value (SV) is 102°C and the actual temperature is 100°C. Thus, the process temperature value (SV) exceeds the actual temperature by +2°C. The sensor compensation required on the process value will be -2°C.

Sensor error (actual temperature - process temperature value):

$$100^{\circ}\text{C} - 102^{\circ}\text{C} = -2^{\circ}\text{C}$$

Full-scale input range (maximum value - minimum value):

$$200^{\circ}\text{C} - (-200^{\circ}\text{C}) = 400^{\circ}\text{C}$$

Sensor compensation value (sensor error/full-scale input range  $\times$  100)

$$-2^{\circ}\text{C} / 400^{\circ}\text{C} \times 100 = 0.5\%$$

(Set up "-50" in the buffer memory.)

### 3.3.6 Unused channel setting

---

#### (1) Channels not connected to the thermocouple

The A1S62TC performs an upscale processing to the channels not connected to the thermocouple. Therefore, when the channel which will not perform temperature control is not connected to a thermocouple, the PV value is determined to be exceeding the measured temperature range specified in the input range and the "ALM" LED is turned on by the alert processing.

#### (2) Unused channel setting

(a) When setting an unused channel, write "1" in the buffer memory for unused channel setting.

(b) If conduct the unused channel setting, channels not connected to a thermocouple will not have an alert, or the "ALM" LED will not turn on.

However, even if the unused channel setting is performed, the sampling period stays unchanged.



**3.3.7 PID output forced stop****(1) PID output forced stop**

The PID output forced stop is a function to temporarily stop the PID operations from the PLC CPU. The action of the A1S62TC when the PID operations are stopped depends on the setting of the stop mode buffer memory (21H, 41H).

**(2) Executing the PID output forced stop**

When performing a PID output forced stop, the PID output forced command (Y1A, Y1B) is turned on. At this time, the buffer memory for manipulation value storage (DH, EH) is at -50 (-5.0%).

**(3) Canceling the PID output forced stop**

When the PID output forced stop command is turned off, the PID output forced stop is canceled. The PID operations are restarted at the manipulation value which was being output during the PID output forced stop.

**Point**

When the PLC CPU is in the STOP state, the PID output forced stop command is turned off, and thus, it will be in the "PID forced stop cancel" state.

**3.3.8 Heater wire breakage detection function (supported only by A1S62TCTTBW-S2)****(1) Heater wire breakage detection function**

- (a) This is a function to check if there is a heater wire breakage using the standard heater current value (load current value detected by the current sensor (CT)), when the transistor output is on.
- (b) The heater wire breakage detection function compares the current values of standard heater and heater wire breakage alert, and determines that there is a heater wire breakage when the current value of standard heater is below that of heater wire breakage alert.  
However, when the transistor turned-on time is less than 0.5 seconds, the heater wire breakage detection is not performed.

**(2) Heater wire breakage compensation function**

- (a) Heater wire breakage compensation  
When the heater voltage drops, the heater current decreases as well. The A1S62TCTTBW-S2 heater wire breakage detection measures the heater current and determines the heater disconnection. Therefore, when the heater voltage drops, there are possibilities that a false alarm may be set due to the voltage change. Therefore, the A1S62TCTTBW-S2 compensates for a drop in heater current (heater breakage compensation) so that the drop in heater current does not activate the break detection.

(b) Heater wire breakage compensation method

The heater wire breakage compensation calculates "the heater current for each channel" - "the standard heater current value" and the largest positive value is set as the compensation value. When there is no positive values, the value with the smallest negative value is used as the compensation value. The heater current for each channel is compensated with the compensation value and a heater wire breakage is detected when the compensated value exceeds the specified the heater disconnection alert set value.

Example 1: When the difference from the standard heater current value at each channel is: Channel 1: 5%, Channel 2: -17%, the compensation value becomes 5%.

The heater wire breakage detection is performed from the values after a 5% compensation: Channel 1: 0%, Channel 2: -22%.

Thus, when the heater disconnection alert set value is at 80%, only channel 2 is detected as disconnected.

Channel No.	The heater disconnection alert set value	Difference from the standard heater current value	Compensation value	Difference from the standard current after compensation	Disconnected
1	80%	5%	5%	0%	No
2		-17%		-22%	Yes

Example 2: The difference from the standard heater current value at each station is: Channel 1: -16%, Channel 2: -17%, the compensation value becomes -16%.

The heater wire breakage detection is performed from the values after a -16% compensation: Channel 1: 0%, Channel 2: -1%.

Thus, when the heater disconnection alert set value is at 80%, none of the channels are detected as disconnected.

Channel No.	The heater disconnection alert set value	Difference from the standard heater current value	Compensation value	Difference from the standard current after compensation	Disconnected
1	80%	-16%	-16%	0	No
2		-17%		-1%	No

(c) Restrictions

- The heater wire breakage compensation function will not work if only one channel is used.
- The heater-disconnection compensation function will not work if only one channel is used to keep the heater on while the others are used to keep it off.  
The module may detect a disconnection even when the heater is not disconnected.
- The heater disconnection alert compensation value is up to 20%.  
When the heater disconnection alert set value is set to 80%, there is a voltage drop by more than 40%, a disconnection is detected even with a 20% compensation.

**3.3.9 Current error detection function when output is off (supported only by A1S62TCTTBW-S2)**

(1) This is a function to check if there is a current error using the standard heater current value (load current value detected by the current sensor (CT)), when the transistor output is on.

(2) The transistor output off-time current error detection function compares the reference heater current value and the current value of the heater disconnection alert, and judges it as an output off-time current error if the reference heater current value is higher than the current value of the output off-time current alert.

However, when the transistor output off time is less than 0.5 seconds, the current error detection when the output is off is not performed.

**3.3.10 Data storage in E<sup>2</sup>PROM**

**(1) Data storage in E<sup>2</sup>PROM**

- (a) The A1S62TC can store data in the buffer memory in the E<sup>2</sup>PROM for backup.  
 This function can be used for backing up the PID constants set by auto-tuning, or data written directly to the buffer memory.  
 When a write to the E<sup>2</sup>PROM is performed, the program to set data in the A1S62TC can be eliminated.
- (b) The backup data is transferred to the buffer memory from the E<sup>2</sup>PROM when booting up (turning on) or resetting the PLC CPU. Therefore, it is not necessary to write data each time the PLC CPU is started or reset to perform temperature adjustment.

**(2) Writing data to E<sup>2</sup>PROM**

- (a) When writing data to the E<sup>2</sup>PROM, the E<sup>2</sup>PROM backup command (Y18) is turned on.
  - When the data write to the E<sup>2</sup>PROM is completed successfully, the E<sup>2</sup>PROM write complete flag (X8) is turned on.
  - When the data write to the E<sup>2</sup>PROM is not completed successfully, the E<sup>2</sup>PROM write incomplete flag (XA) is turned on.
- (b) Perform changes to the buffer memory when the E<sup>2</sup>PROM write complete flag is off.

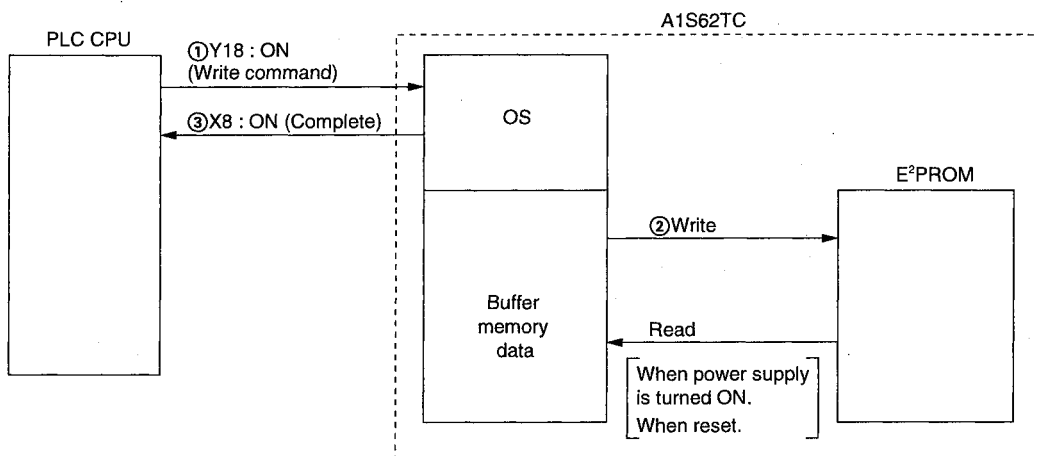

**3.3.11 Alert alarm**

(1) The alert alarm is a function to set the system in an alert status when the process value (PV) or the deviation reaches the alert set value. This is used when operating the device's caution signals or the safety device.

The alert alarm is categorized in the following manner:

- Input alert ..... Upper-limit input alert, Lower-limit input alert
- Deviation alert ..... Upper-limit deviation alert, Lower-limit deviation alert, Upper/lower-limit deviation alert, Within the range alert

(a) Input alert

1) Upper-limit input alert

When the process value (PV) exceeds the alert set value, the alert status is reached.

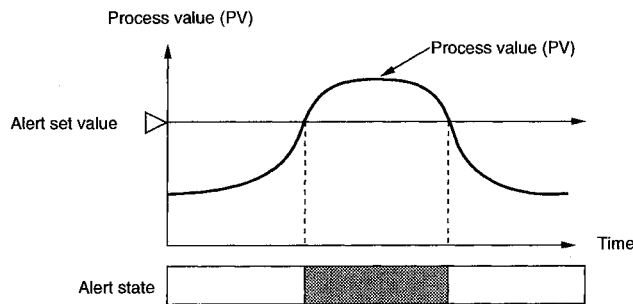

2) Lower-limit input alert

When the process value (PV) is below the alert set value, the alert status is reached.

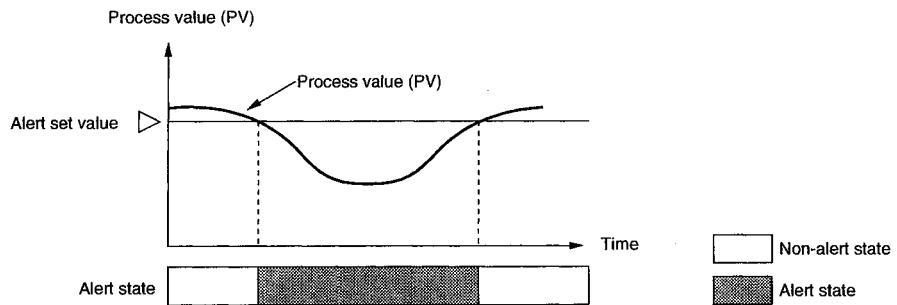

(b) Deviation alert

1) Upper-limit deviation alert

When the deviation (process value (PV) - set value (SV)) is above the alert set value, the alert status is reached.

(When alert set value is positive)

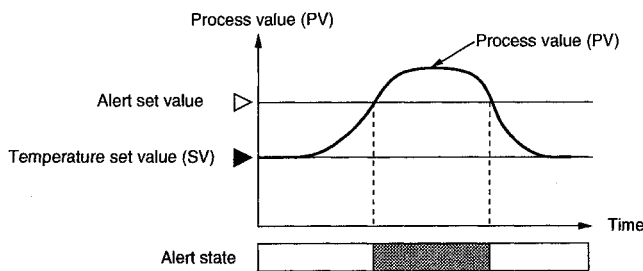

(When alert set value is negative)

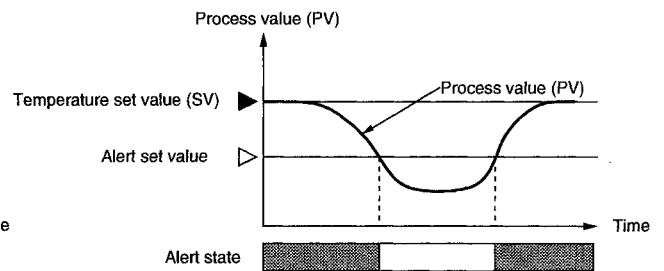

2) Lower-limit deviation alert

When the deviation (process value (PV) — set value (SV)) is below the alert set value, the alert status is reached.

(When alert set value is positive)

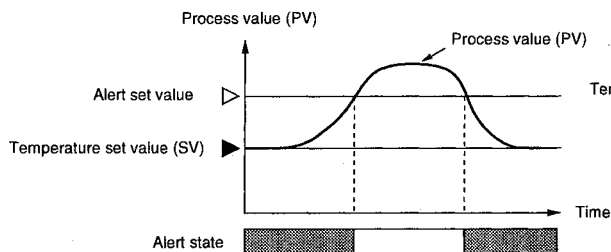

(When alert set value is negative)

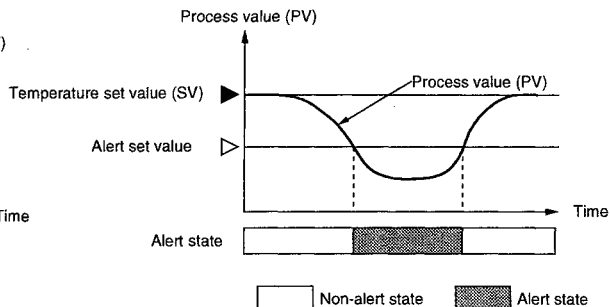

□ Non-alert state    ■ Alert state

3) Upper/lower-limit deviation alert

When the absolute deviation value (process value (PV) — set value (SV)) is above the alert set value, the alert status is reached.

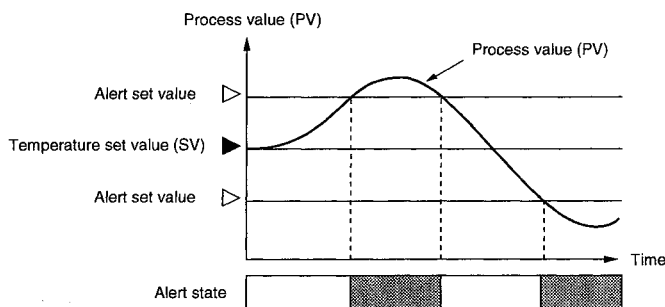

□ Non-alert state    ■ Alert state

4) Within the range alert

When the absolute deviation (process value (PV) — set value (SV)) is below the alert set value, the alert status is reached.

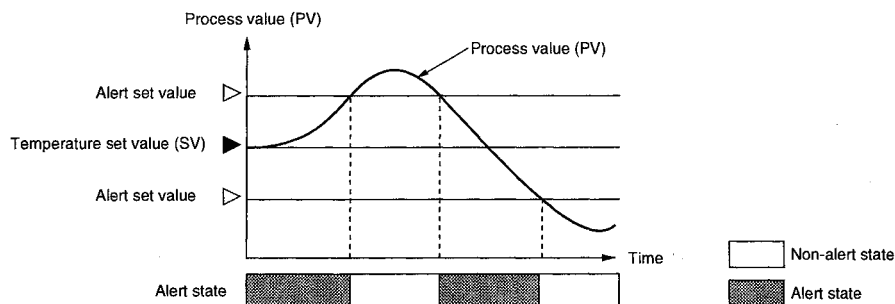

□ Non-alert state    ■ Alert state

(2) The A1S62TC enables the alert alarm settings including the alert blind section setting as described in (1), number of alert delays setting, and wait/re-wait setting. The types of alert alarms that can be used for setting the alert blind section, number of alert delays, and wait/re-wait functions are shown in the following table:

Alert alarm		Blind section setting	Number of alert delays	Wait	Re-wait
Input alert	Upper-limit input alert	○	○	○	—
	Lower-limit input alert	○	○	○	—
Deviation alert	Upper-limit deviation alert	○	○	○	○
	Lower-limit deviation alert	○	○	○	○
	Upper/lower-limit deviation alert	○	○	○	○
	Within the range alert	○	○	—	—

(a) Alert blind section setting

When the process value (PV) and deviation are close to the alert set value, the status may repeat changing between the alert status and normal status due to the input instability. When an alert blind section value is set, the frequent changes of the status can be prevented when the process value (PV) and deviation are close to the alert set value.

Example: When the blind section value is set for the upper-limit input alert, the system goes into the alert status when the input upper limit becomes above the alert set value. When the value is below the alert blind section, it goes back to non-alert status.

(When the alert blind section value is not set)

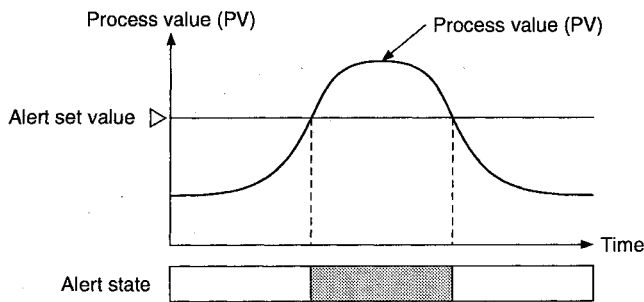

(When the alert blind section value is set)

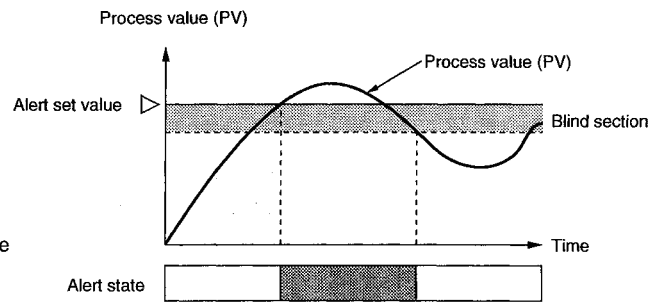

(b) Number of alert delays

The system is set in the alert status when the value remains in the alert rang until the number of samplings exceeds the number of alert delays after the process value (PV) is reached the alert set value.

Example: When the number of alert delays is set to five, the system is not set in the alert status with four or less samplings.

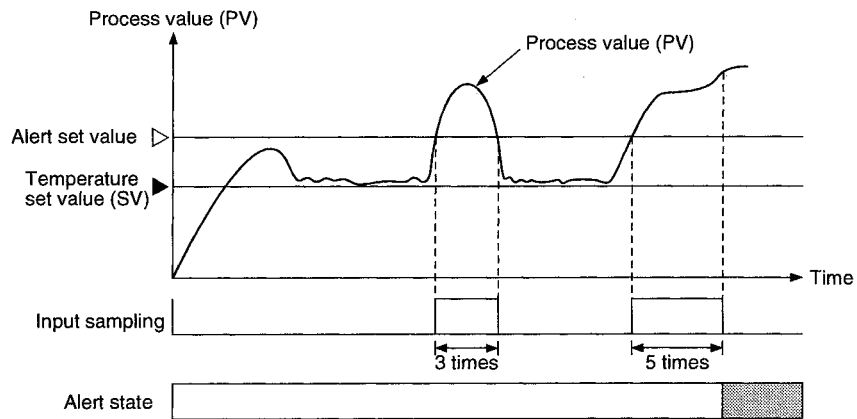

(c) Wait alert

If the wait alert is selected, when the system is switched from the setting mode to the operation mode, the alert function can be invalidated until the process value once gets out of the alert status, even though the process value (PV) and deviation are in the alert status rang.

Example: When the lower-limit deviation alert with wait is selected, the alert function is invalidated until the process value exceeds the alert set value.

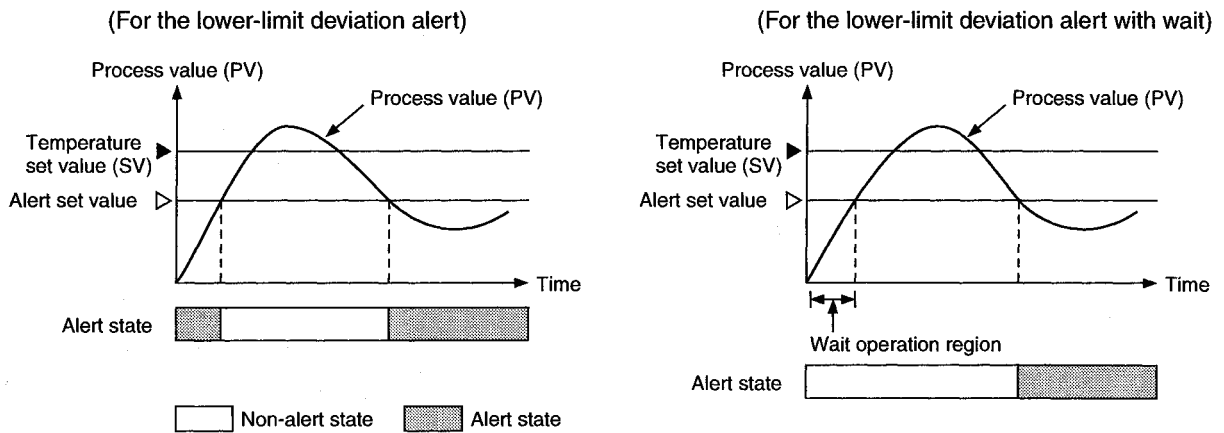

**Point**

If the alert set value is reached the wait function will not operate even if once after the power is turned on or even if the mode with wait is changed.

(d) Re-wait alert

The re-wait alert is a function added to the wait alert, to make the alert function invalid once again when the temperature set value (SV) is changed.

By selecting the re-wait alert, it is possible to prevent from becoming the alert status during the temperature set value change when performing the change control of the temperature set value.

Example: Before changing the setup, if the process value (PV) is at the position as shown below, the process value enters the alert region and turns on the alert when the temperature set value (SV) for deviation alert is changed. To prevent this from happening, make the alert wait operation valid and postpone the alert output.

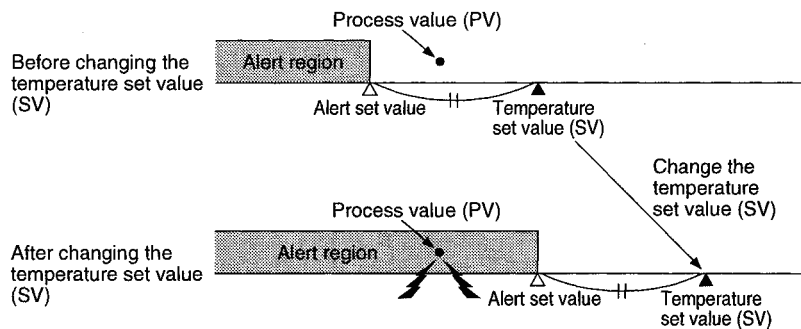

(3) The A1S62TC allows selections for four alarms (alert alarm 1 to 4) from the alert alarm, alert alarm with wait, and alert alarm with re-wait.

The alert alarms used for alert alarms 1 through 4 are set in the buffer memory shown below:

- Alert alarm 1: A0H
- Alert alarm 2: A1H
- Alert alarm 3: A2H
- Alert alarm 4: A3H

- (4) The alert set value, alert blind section value, and the number of alert delays are set in the buffer memory shown below:

Channel No.	Buffer memory address		
	Alert set value	Alert blind section value	Number of alert delays
1	26H to 29H	A4H	A5H
2	46H to 49H		

**3.3.12 Settings and control status of the output signals and buffer memory that control the A1S62TC control status**

For the A1S62TC, output signals (Y) and buffer memory for control status setting are provided. The A1S62TC control statuses in settings of output signals and buffer memory are described below.

- (1) Unused channel setting

Unused channel setting (Refer to Section 3.6.26.)	Control status		
3DH, 5DH	PID control	Temperature determination	Alert determination
Unused	—	—	—
Used	In accordance with control status of other setting items		

○ : Execute, — : Not execute

- (2) Other setting

Setting/operation mode command (Refer to Section 3.5.3.) *	PID continuation flag (Refer to Section 3.6.33.)	PID output forced stop command (Refer to Section 3.5.3.)	Stop mode setting (Refer to Section 3.6.13.)	Control status				
				PID control	Temperature determination	Alert determination		
Y11	A9H	Y1A, Y1B	21H, 41H	—	—	—		
1) Setting mode (at power-on)	Stop/Continue	OFF/ON	Stop	—	—	—		
			Monitor	—	○	—		
			Alert	—	○	○		
2) Operation mode (during operation)	Stop/Continue	OFF	Stop/Monitor/Alert	○	○	○		
			ON	Stop	—	—	—	
				Monitor	—	○	—	
3) Setting mode (after operation)	Stop	OFF/ON	Alert	—	○	○		
			Continue	OFF	Stop/Monitor/Alert	○	○	○
					ON	Stop	—	—
	ON	Monitor	—	○		—		
		Alert	—	○	○			

○ : Execute, — : Not execute

\*: The setting of the setting/operation mode command is explained in the following three different modes

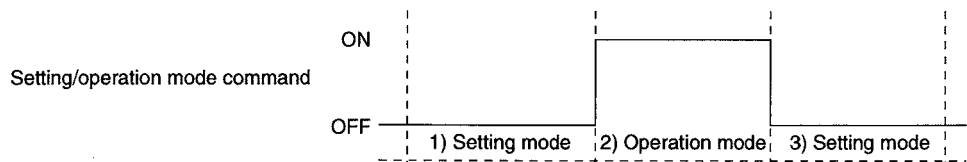



### 3.4 Sampling Period and Heating-Cooling Control Output Period

#### (1) Sampling period

- (a) The A1S62TC executes alternately the PID operations in the following order: CH1 → CH2 → CH1 → CH2 →....

The time from the start of PID operation at a channel (CHn) until the start of the next PID operation at the same channel (CHn) is called sampling period.

- (b) The sampling period is 0.5 seconds regardless of number of channels used.

Unused channels also perform error checking, so the sampling period does not change even if unused channels are specified.

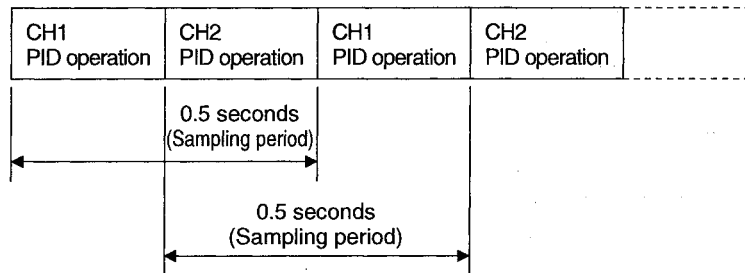

#### (2) Heating-cooling control output period

- (a) The heating-cooling control output period represents a period for the ON/OFF cycle of the transistor output.

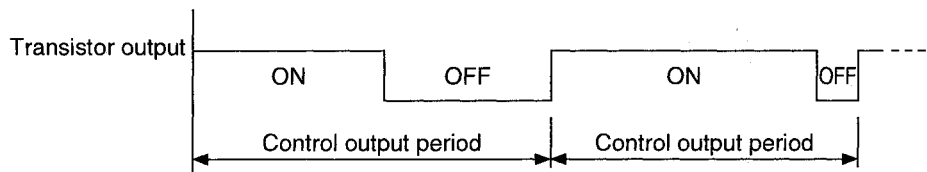

The manipulated value (MV) expresses the ON time of the heating-cooling control output period as a percentage or digital output value. (Refer to Section 3.6.6, 3.6.7.)

- (b) The heating-cooling control output period is set in the buffer memory for the heating-cooling control output period setting (2FH, 4FH/D2H, E2H) in the range from 1 to 100 seconds.

### 3.5 I/O Signals for the PLC CPU

The following explains the I/O signal allocation and the various functions.

#### 3.5.1 I/O signal list

The A1S62TC uses 32 points for input and 32 points for output for sending and receiving signals with the programmable controller CPU. Table 3.5 shows the I/O signal allocation and each signal's name. Device X means the input signal from the programmable controller CPU to the A1S62TC, an device Y means the output signal from the programmable controller CPU to the A1S62TC.

Hereafter in this chapter the I/O signal X, Y, and I/O address will be shown for when the A1S62TC is installed in the basic base module I/O slot 0.

Table 3.5 I/O signal list

Signal direction: A1S62TC → PLC CPU		Signal direction: A1S62TC ← PLC CPU	
Device No.	Name	Device No.	Name
X0	Watchdog timer error flag	Y00 to Y10	Unusable
X1	Temperature adjustment module READY flag	Y11	Setting/action mode command
X2	Write error flag	Y12	Error reset command
X3	Hardware error flag	Y13	Unusable
X4	CH1 Auto-tuning status	Y14	CH1 Auto-tuning command
X5	CH2 Auto-tuning status	Y15	CH2 Auto-tuning command
X6	Unusable	Y16	Unusable
X7		Y17	
X8	E <sup>2</sup> PROM write complete flag	Y18	E <sup>2</sup> PROM backup command
X9	Default value write complete flag	Y19	Default setting registration command
XA	E <sup>2</sup> PROM write incomplete flag	Y1A	CH1 PID output forced stop command
XB	Unusable	Y1B	CH2 PID output forced stop command
XC	CH1 Alert occurrence flag	Y1C	Unusable
XD	CH2 Alert occurrence flag	Y1D	
XE	Unusable	Y1E	
XF		Y1F	
X10 to X1F			

#### Point

- (1) When the unusable area in Table 3.5 are turned on/off by a sequence program, the functions of the A1S62TC are not guaranteed. And it could result in stop the CPU.  
However, when the A1S62TC is used with the remote I/O station, Y0E and Y0F can be reset from a user program. Refer to the Data Link System Reference Manual for details.

**3.5.2 Input signal function**

**(1) Watchdog timer error flag (X0)**

- (a) This flag is turned on when the watchdog timer error is detected from the A1S62TC self-diagnosis function.
- (b) When the watchdog timer error flag is turned on, the A1S62TC stops the temperature adjustment operation, and turns off the output.

**(2) Temperature adjustment module READY flag (X1)**

- (a) This flag turns on when the temperature module is ready when the power for PLC CPU is turned on or reset.
- (b) Perform read/write in the A1S62TC buffer memory from the PLC CPU when the temperature module ready flag is on.

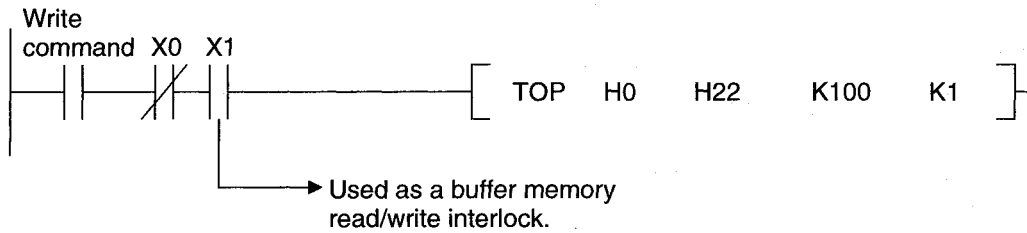

**(3) Write error flag (X2)**

- This signal turns on at write error occurrence.  
 A write error occurs under any of the following conditions.
- When data is set to the reserved area.
  - When a setting change made to the area write-enabled in the setting mode only is made in the operation mode.
  - When data outside the setting range is set.
  - When data setting is changed during default setting registration.

**(4) Hardware (H/W) error flag (X3)**

This flag turns on when the temperature adjustment module results in a hardware error.

**(5) Auto-tuning status flag (X4, X5)**

- (a) This flag is turned on when executing the auto-tuning for each channel.

Channel	Auto-tuning status flag	ON/OFF status
1	X4	ON: Auto-tuning in execution
2	X5	OFF: Auto-tuning not executing or is complete

- (b) The auto-tuning is executed by the auto-tuning command (Y14, Y15).
- (c) The flag turns on during auto-tuning execution and automatically turns off when the execution is complete.

**(6) E<sup>2</sup>PROM write complete flag (X8)**

- (a) This flag is turned on after the writing of the buffer memory contents to the E<sup>2</sup>PROM is complete when E<sup>2</sup>PROM backup command (Y18) is on.
- (b) When the E<sup>2</sup>PROM backup command is turned off, the E<sup>2</sup>PROM write completion flag turns off as well.

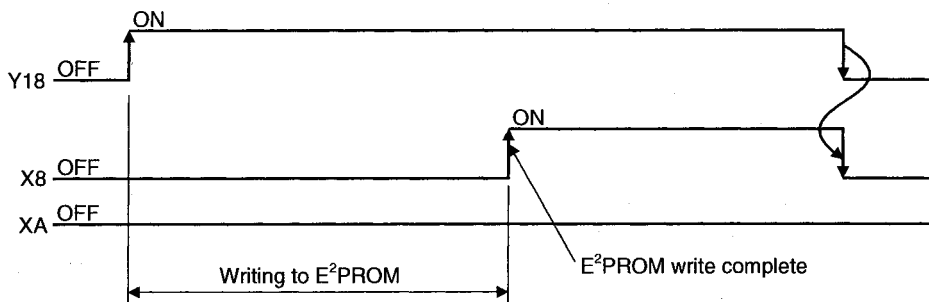
**(7) Default value write complete flag (X9)**

- (a) This flag is turned on after the writing of the A1S62TC default values to the buffer memory is complete when the default setting registration command (Y19) is on.
- (b) When the default setting registration command (Y19) is turned off, the default value write completion flag (X9) turns off as well.
- (c) Perform "unused" setting again for the unused channels after writing the default values.  
When an unused channel is not set as unused, the A1S62TC's "ALM" LED turns on.

**(8) E<sup>2</sup>PROM write incomplete flag (XA)**

- (a) This flag is turned on when the writing of the buffer memory contents to the E<sup>2</sup>PROM is incomplete when the E<sup>2</sup>PROM backup command (Y18) is on.
- OFF: Write to E<sup>2</sup>PROM is completed, or the write operation has not been executed yet.
  - ON: Write to E<sup>2</sup>PROM did not finish normally.

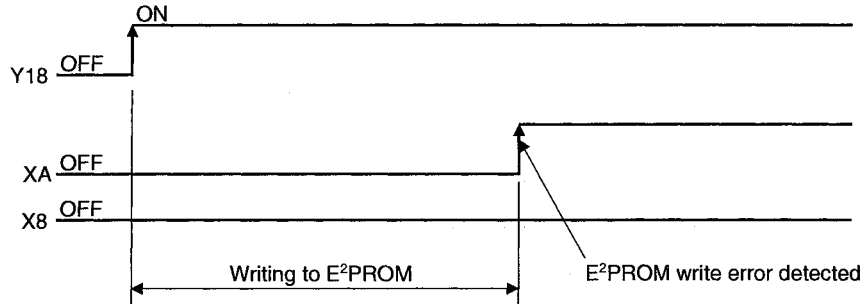

- (b) The E<sup>2</sup>PROM write incomplete flag is turned off when the write to the E<sup>2</sup>PROM is completed successfully.
- (c) When the E<sup>2</sup>PROM write incomplete flag is turned on, the E<sup>2</sup>PROM contents are undefined. Therefore, when the power for PLC CPU is restarted or reset when the E<sup>2</sup>PROM write incomplete flag is on, the buffer memory contents become undefined, resulting in A1S62TC operation with its default values.

**(9) Alert occurrence flag (XC, XD)**

- (a) This flag is turned on when an alert has occurred for each channel.

Channel	Alert occurrence flag	ON/OFF status	Buffer memory address for storing the alert details
1	XC	OFF: No alert occurrence	5H
2	XD	ON: Alert occurrence	6H

- (b) When the alert occurrence flag is turned on, the alert details are stored in the buffer memory (05H, 06H).

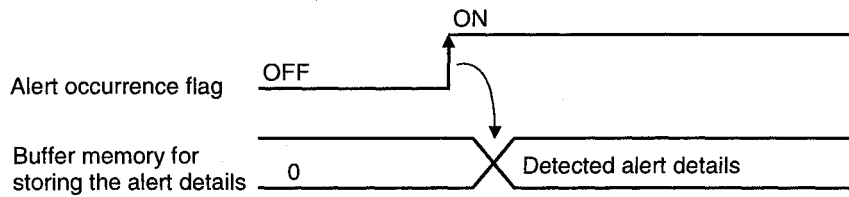

### 3.5.3 Output signal function

#### (1) Setting mode/operation mode command (Y11)

- (a) This is a signal to set the operation mode of the temperature adjustment function.
- OFF: Setting mode
  - ON: Operation mode
- (b) Sets all 2 channels at once.
- (c) Refer to Section 3.3.11 for the A1S62TC operation when the setting mode/operation mode selection command is turned on or off.

#### (2) Error reset command (Y12)

- (a) This is a signal to turn off the write error flag (X2) and clears (resets) the buffer memory for the write data error code storage.
- (b) By turning on the error reset command, the "RUN" LED on the A1S62TC front panel changes to on from the flashing state.

#### (3) Auto-tuning command (Y14, Y15)

- (a) This is a signal to start auto-tuning.
- (b) Auto-tuning is started when the auto-tuning command (Y14, Y15) is turned on and the auto-tuning status flag (X4, X5) is turned on. When the auto-tuning is complete, the auto-tuning status flag (X4, X5) is turned off.
- (c) The auto-tuning command should be turned on while auto-tuning is being executed, and turned off when the auto-tuning is complete.
- (d) When the auto-tuning command is turned off during auto-tuning execution, the execution is interrupted.

When auto-tuning is interrupted, the PID constants in the buffer memory remain unchanged.

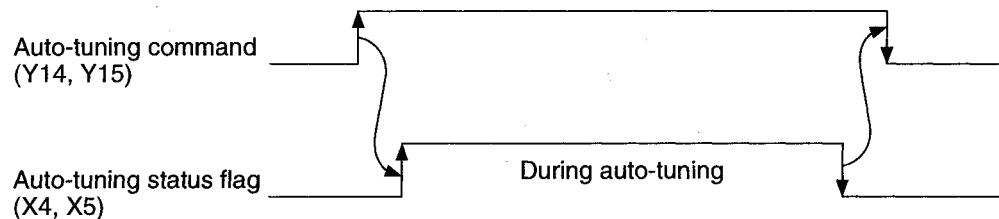

**(4) E<sup>2</sup>PROM backup command (Y18)**

- (a) This is a signal to write the buffer memory contents to the E<sup>2</sup>PROM.
- (b) When the E<sup>2</sup>PROM backup command is turned on, the buffer memory contents are written to the E<sup>2</sup>PROM.
- 1) When the write is completed successfully, the "E<sup>2</sup>PROM write complete flag (X8)" is turned on.
  - 2) If the E<sup>2</sup>PROM write is not successful the "E<sup>2</sup>PROM write incomplete flag (XA)" is turned on. When XA is turned on, turn on the E<sup>2</sup>PROM backup command again and perform write to the E<sup>2</sup>PROM.

**Point**

The number of writes to E<sup>2</sup>PROM is 100,000 times.

Reduce the number of writes by avoiding writing to E<sup>2</sup>PROM when setting the PID constants, etc. during the PLC CPU startup.

**(5) Default setting registration command (Y19)**

- (a) This is a signal to return the buffer memory contents to the default values. When the default setting registration command is turned on, the A1S62TC default values are written to the buffer memory. When complete, the default value write complete flag (X9) is turned on.
- (b) Perform the default setting while in the setting mode (Y11:OFF).  
Default setting cannot be performed while in the operation mode (Y11: ON).

**(6) PID output forced stop command (Y1A, Y1B)**

- (a) This is a signal to forcefully stop the PID operation at each channel.
- (b) The mode when the PID operation is stopped is determined by the setting in the buffer memory for the stop mode setting (21H, 41H).
- (c) Refer to Section 3.3.11 for the control status when the PID forced stop is executed.

**DANGER**

Even when the PID operation is stopped by turning on the PID output forced stop command (Y1A, Y1B) and the PLC CPU is in the stop state, the channel which issued the command to stop the PID operation will continue executing the PID operation.

When placing the PLC CPU to a stop state, set the channel that issued the PID output forced stop command to "unused."

## 3.6 Buffer Memory

### 3.6.1 Buffer memory list

Table 3.6 Buffer memory list

Address (Hex.)		Buffer memory address name	Setting/selection range
CH1	CH2		
0		Write data error code	—
1	2	Decimal point position	—
5	6	Alert occurrence details	—
9	A	Temperature process value (PV)	—
D	E	Heating manipulation value (MV)	—
11	12	Increased temperature determination flag	—
15	16	Heating transistor output flag	—
19	1A	Heater current process value *1	—
1D		Cooling contact temperature process value	—
20	40	Input range	—*2
21	41	Stop mode setting	0: Stop, 1: Monitor, 2: Alarm
22	42	Set value (SV) setting	Depends on the upper/lower setting limiter
23	43	Heating proportional band (Ph) setting	1 to 10000 (0.1 to 1000.0%)
24	44	Integral time (I) setting	1 to 3600s
25	45	Derivative time (D) setting	0 to 3600s
26	46	Alert alarm 1 set value	Depends on the input range
27	47	Alert alarm 2 set value	
28	48	Alert alarm 3 set value	
29	49	Alert alarm 4 set value	
2A	4A	Heating-cooling upper output limiter setting	0 to 1050 (0.0 to 105.0%)
2D	4D	Sensor compensation value setting	-5000 to 5000 (-50.00 to 50.00%)
2F	4F	Heating control output cycle setting	1 to 100s
30	50	First-order delay digital filter setting	0 to 100s
31	51	Control response parameter	0: Slow, 1: Normal, 2: Fast
34	54	Setting change rate limiter	0 to 1000 (0.0 to 100.0%/min)
37	57	Upper setting limiter	Within measurement range
38	58	Lower setting limiter	
39	59	CT selection	0: 0.0 to 100.0A, 1: 0.00 to 20.00A
3A	5A	Heater wire breakage alert setting *1	0 to 100%
3D	5D	Not used channel setting	0: Used, 1: Unused
A0		Alert alarm 1 mode setting	0 to 14
A1		Alert alarm 2 mode setting	
A2		Alert alarm 3 mode setting	
A3		Alert alarm 4 mode setting	
A4		Alert blind section setting	0 to 100 (0.0 to 10.0%)
A5		Number of alert delays	0 to 255 times
A6		Number of delays for heater wire breakage/current error detection when output is turned off *1	3 to 255 times
A7		Temperature increase complete range setting	1 to 10°C (°F)
A8		Temperature increase complete soak time setting	0 to 3600min
A9		PID continue flag	0: Stop, 1: Continue
AA		Heater voltage compensation function setting *1	0: OFF, 1: ON
AB	AC	Standard heater current value *1	Heater current range
AF		Transistor output monitor ON delay time setting	0 to 50 (0 to 500ms)
B0		CT monitor method switch	0: ON current/OFF current, 1: ON current
B1	B2	Heating manipulated value (MV) (0 to 4000)	—
C0	C1	Cooling manipulated value (MV)	—
C2	C3	Cooling manipulated value (MV) (0 to 4000)	—
C4	C5	Cooling transistor output flag	—
CF		Cooling method setting	0: Air cooling, 1: Water cooling
D0	E0	Cooling proportional band (Pc) setting	1 to 10000 (0.1 to 1000.0%)
D1	E1	Cooling upper output limiter	0 to 1050 (0.0 to 105.0%)
D2	E2	Cooling control output cycle setting	1 to 100
D3	E3	Overlap/dead band	-100 to 100 (-10.0 to 10.0%)

The buffer memory addresses which are not listed above will not be used.

\*1: Only A1S62TCTTBW-S2 can be used.

\*2: Depends on the numeric value of the thermocouple to be used. Refer to 3.6.12 for details.



	Default value (Decimal)		Write condition (read is always enabled)			Reference
	A1S62TCTT-S2	A1S62CTTBW-S2	Always possible	When in the setting mode	Not possible	
	—		○			Section 3.6.2
	0				○	Section 3.6.3
	—				○	Section 3.6.4
	—				○	Section 3.6.5
	—				○	Section 3.6.6
	—				○	Section 3.6.8
	—				○	Section 3.6.9
	—				○	Section 3.6.10
	—				○	Section 3.6.11
	7			○		Section 3.6.12
	1		○			Section 3.6.13
	0		○			Section 3.6.14
	30 (3.0%)		○			Section 3.6.15
	240s		○			
	60s		○			
	0		○			Section 3.6.16
	1000 (100.0%)		○			Section 3.6.17
	0		○			Section 3.6.18
	30 (30s)		○			Section 3.6.19
	0		○			Section 3.6.20
	2		○			Section 3.6.21
	0		○			Section 3.6.22
	1300		○			Section 3.6.23
	0		○			
	0		○			Section 3.6.24
	0%		○			Section 3.6.25
	0		○			Section 3.6.26
	0			○		Section 3.6.27
	5		○			Section 3.6.28
	0		○			Section 3.6.29
	3		○			Section 3.6.30
	1		○			Section 3.6.31
	0		○			Section 3.6.32
	0		○			Section 3.6.33
	0		○			Section 3.6.34
	0		○			Section 3.6.35
	0		○			Section 3.6.36
	0		○			Section 3.6.37
	—				○	Section 3.6.7
	—				○	Section 3.6.6
	—				○	Section 3.6.7
	—				○	Section 3.6.9
	0		○			Section 3.6.38
	30 (3.0%)		○			Section 3.6.15
	1000 (100.0%)		○			Section 3.6.17
	30s		○			Section 3.6.19
	0		○			Section 3.6.39

### 3.6.2 Write data error code (buffer memory address: 0H)

Stores the error code and the buffer memory address of the error detected when a write is performed from the PLC CPU to the A1S62TC buffer memory.

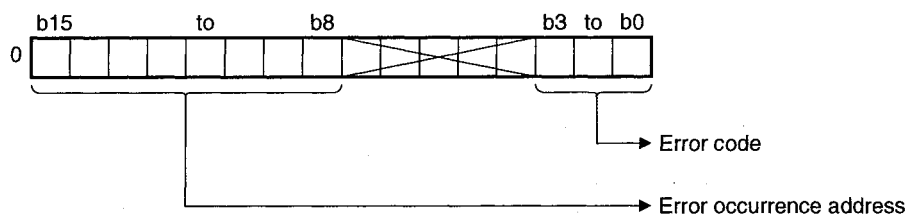

- (1) The A1S62TC checks the following when there is a data write from the PLC CPU:
  - Whether it is a read only area
  - Whether it is a write to the unusable area
  - The range of written data
- (2) When a write error occurs, the following processing will be performed:
  - Stores the error code (Refer to Section 6.1 for details of the error codes.)
  - Flashes the RUN LED on the front panel of the module
  - Turns on the write error flag (X2)
- (3) When multiple errors have occurred, the error code and error occurrence address of the error with the highest priority is stored.
- (4) Refer to Section 6.1 to cancel the error.

### 3.6.3 Decimal point position (buffer memory address: 1H, 2H)

- (1) The decimal point position for the data below will be stored according to the input range for determining the measurement temperature range.
  - Temperature process value (PV)
  - Set value (SV)
  - Alert set value

A "1" will be stored if a temperature measurement range input range with a decimal point has been set.

A "0" will be stored if a temperature measurement range input range without a decimal point has been set.
- (2) Refer to the table below when performing a write/read of the above data from the PLC CPU:

Decimal point position	When reading	When writing
0	The buffer memory data is read as is and used in sequence programs, etc.	Write the specified value as is.
1	One tenth of the actually read value from a sequence program, etc. is used as the actual value.	Write the value 10 times the specified value.



### 3.6.6 Heating-cooling manipulated value (MV value, buffer memory address: DH, EH/C0H, C1H)

- (1) Stores the temperature value read from the thermocouple after performing the PID operation.
- (2) The value stored is in the range -50 to 1050 (-5.0% to 105.0%).  
However, when output is performed externally, the value is in the range 0 to 100%.
  - When below 0%: 0%
  - When above 100%: 100%
- (3) The heating-cooling manipulated value is indicated by percentage (%) for the "on" time of the heating -cooling control output period (buffer memory address: 2FH, 4FH/D2H, E2H).  
When the control output period is 30 seconds and the manipulation value is 600 (60.0%), the pulse turns on for 18 seconds and off for 12 seconds.

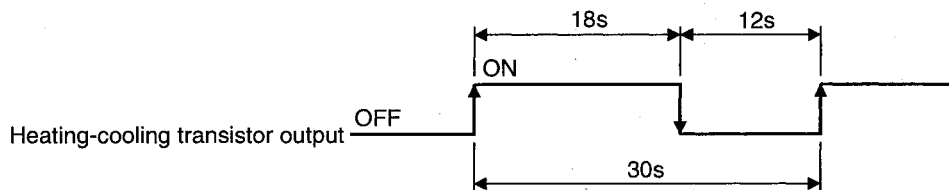

### 3.6.7 Heating-cooling manipulated value (MV value: 0 to 4000; buffer memory address: B1H, B2H/C2H, C3H)

- (1) The manipulated value from Section 3.6.6 for heating-cooling is stored here in digital value for output to the digital-analog conversion module.
- (2) The range of storage values is 0 to 4000 (MV values of -5.0 to 0.0 % and 100.0 to 105.0 % will be shown as "0" and "4000," respectively).
- (3) If the heating or cooling source is of the analog-input type, convert the value to analog quantity by outputting it to the digital-analog conversion module.

### 3.6.8 Temperature increase determination flag (buffer memory address: 11H, 12H)

- (1) This is a flag to check whether the temperature process value (PV) is within the temperature increase completion range.
- (2) If the temperature process value is within the temperature increase completion range, the flag is set to "1."  
If the temperature-increase complete soak time (buffer memory address: A8H) is set, the flag is set to "1" when the temperature process value is within the specified temperature-increase completion range of the temperature-increase completion soak time.

### 3.6.9 Heating-cooling transistor output flag (buffer memory address: 15H, 16H/C4H, C5H)

- (1) The on/off status of the heating transistor output and on delay output are stored.

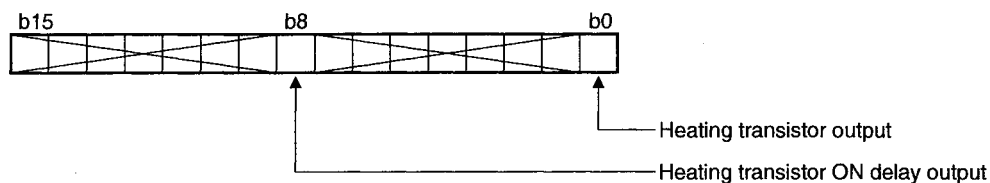

- (2) The on/off status of the cooling transistor output is stored.

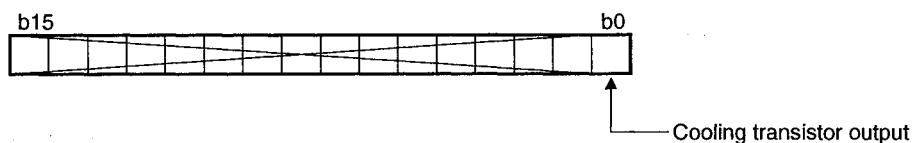

- (3) Stores the following value for the heating-cooling transistor output and heating transistor on delay output:

- ON: 1
- OFF: 0

### 3.6.10 Heater current process value (buffer memory address: 19H, 1AH)

- (1) The heater current detected by the A1S62TC is stored.
- (2) Stores the value within the range specified by the CT selection (buffer memory address: 39H, 59H)  
Held at the upper limit value if the heater current value exceeds the upper limit value of the measurement range.

### 3.6.11 Cooling contact temperature process value (buffer memory address: 1DH)

- (1) The temperature measured with the cooling contact compensation resistor installed on the A1S62TC is stored.

**3.6.12 Input range (buffer memory address: 20H, 40H)**

- (1) The types of thermocouple connected to the A1S62TC and the input range setting are shown in Table 3.7. Set the input values for the thermocouple type used and operation temperature range according to Table 3.7.

Be sure to set the input range during the setting mode (Y11: OFF)

**Table 3.7 Thermocouple types and input range setting list**

Thermocouple type	°C			°F		
	Measurement temperature range	Input range setting	Setting unit	Measurement temperature range	Input range setting	Setting unit
R	0 to 1700	1	1	0 to 3000	105	1
K	0 to 500	11	1	0 to 1000	100	1
	0 to 800	12	1	0 to 2400	101	1
	0 to 1300	2	1	0.0 to 1000.0	130	0.1
	-200.0 to 400.0	38	0.1	—	—	—
	0.0 to 400.0	36	0.1	—	—	—
	0.0 to 800.0	41	0.1	—	—	—
J	0 to 500	13	1	0 to 1000	102	1
	0 to 800	14	1	0 to 1600	103	1
	0 to 1200	3	1	0 to 2100	104	1
	0.0 to 400.0	37	0.1	0.0 to 1000.0	131	0.1
	0.0 to 500.0	42	0.1	—	—	—
	0.0 to 800.0	43	0.1	—	—	—
T	-200 to 400	4	1	0 to 700	109	1
	-200 to 200	21	1	-300 to 400	110	1
	0 to 200	19	1	0.0 to 700.0	132	0.1
	0 to 400	20	1	—	—	—
	-200.0 to 400.0	39	0.1	—	—	—
	0.0 to 400.0	45	0.1	—	—	—
S	0 to 1700	15	1	0 to 3000	106	1
B	400 to 1800	16	1	800 to 3000	107	1
E	0 to 400	17	1	0 to 1800	108	1
	0 to 1000	18	1	—	—	—
	0.0 to 700.0	44	0.1	—	—	—
N	0 to 1300	22	1	0 to 2300	111	1
U	0 to 400	25	1	0 to 700	114	1
	-200 to 200	26	1	-300 to 400	115	1
	0.0 to 600.0	46	0.1	—	—	—
L	0 to 400	27	1	0 to 800	116	1
	0 to 900	28	1	0 to 1600	117	1
	0.0 to 400.0	47	0.1	—	—	—
	0.0 to 900.0	48	0.1	—	—	—
PLII	0 to 1200	23	1	0 to 2300	112	1
Wre5-26	0 to 2300	24	1	0 to 3000	113	1

- (2) The temperature measurement value may not stabilize for up to 8 seconds after the input range has been changed.
- (3) When modifying the input range, make sure the upper/lower setting limiters are within the temperature measurable range.

**3.6.13 Stop mode setting (buffer memory address: 21H, 41H)**

- (1) Sets the mode for when the PID operation stopped.  
The default value (initial value) is "monitor."
- (2) Setting of each mode and the operation for each mode are as shown below:

Setting mode	Set value	Operation		
		PID operation	Temperature determination	Alert determination
Stop	0	×	×	×
Monitor	1	×	○	×
Alert	2	×	○	○

○: Execution    ×: Not-executed

However, the operation varies depending on the unused channel setting, the setting mode or operation mode setting, the PID continuation flag, and the forced stop command setting. (Refer to Section 3.3.12.)

- (a) Temperature determination: Performs temperature input from the thermocouple and checks whether it is within the temperature measurement range specified in the input range setting.
- (b) Alert determination: Performs alert alarm 1 to 4 in Section 3.6.4.

Point
The default value (initial value) for the stop mode is "monitor." Therefore, channels not connected to a thermocouple is determined to have sensor input disconnection, and the "ALM" LED turns on. For the channels not connected to a thermocouple set "1 (not used)" in the not used channel setting buffer memory (3DH, 5DH).

**3.6.14 Set value (SV) setting (buffer memory address: 22H, 42H)**

- (1) Sets the PID operation set value temperature.
- (2) The setting range is within the range specified in the upper/lower setting limiter (refer to Section 3.6.23).
- (3) When setting a value outside the setting range, it results in write error and the write error flag (X2) turns on, then the error code (4) is stored in the buffer memory address 0.

**3.6.15 PID constant setting (buffer memory address: 23H to 25H, 43H to 45H, D0H, E0H)**

- (1) Sets the proportional band (P), integral time (I), and derivative time (D) to perform PID operations.
- (2) Set the values for the heating proportional band (Ph), cooling proportional band (Pc), integral time (I), and derivative time (D) within the following range:

Item	Address (hexadecimal)		Setting range	Constant in the PID operation
	CH.1	CH.2		
Heating proportional band (Ph) setting	23H	43H	1 to 10000	0.1 to 1000.0%
Cooling proportional band (Pc) setting	D0H	E0H		
Integral time (I) setting	24H	44H	1 to 3600	1 to 3600ms
Derivative time (D) setting	25H	45H	0 to 3600	0 to 3600ms

- (a) Set the heating proportional band (Ph) and the cooling proportional band (Pc) as a percentage (%) to the full scale of the set input range.  
For example, if the A1S62TCTT-S2 is used with the input range set to 38 (-200.0 to 400.0°C) and the heating proportional band is 10.0%, the heating proportional band will be set to 60.0°C.
- (b) When performing PI control, set the derivative time to "0."

**3.6.16 Alert alarm 1 to 4 setting (buffer memory address: 26H to 29H, 46H to 49H)**

- (1) Set the temperature value that turns on the alert alarm 1 to 4 ( mode setting: buffer memory address A0H to A3H) on.
- (2) The setting range is within the temperature setting range specified in the input range setting (refer to Section 3.6.12).
- (3) If a value outside the set range has been set, or if a value other than "0" has been set for the setting range with the mode setting "0", a write error will occur, write error flag (X2) will be set to ON and error code (4) will be stored in buffer memory address 0.

**3.6.17 Heating-cooling upper output limiter setting (buffer memory address: 2AH, 4AH/D1H, E1H)**

- (1) Set the upper limit values for performing actual output of the heating-cooling manipulated value (MV) calculated with the PID operations to an external device.  
The heating-cooling upper output limiter settings are ignored for output during auto-tuning.
- (2) The setting range is 0 to 1050 (0% to 105.0%).

**3.6.18 Sensor compensation value setting (buffer memory address: 2DH, 4DH)**

- (1) Set the compensation value when there is an error between the temperature measured by the thermocouple and the actual temperature due to the measurement condition, etc. (Refer to Section 3.3.5.)
- (2) The setting range is -5000 to 5000 (-50.00% to 50.00%).

**3.6.19 Heating-cooling control output period setting (buffer memory address: 2FH, 4FH/D2H, E2H)**

- (1) Set the pulse period of the heating-cooling transistor output.

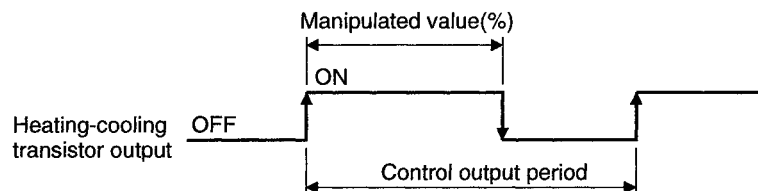

- (2) The setting range is 1 to 100 (1 to 100s).
- (3) The control output period's on time is the control cycle multiplied by the manipulated value (%) calculated by the PID operation. (Refer to Section 3.6.6)



**3.6.20 Temporary-delay digital filter setting (buffer memory address: 30H, 50H)**

- (1) The temporary-delay digital filter is to absorb sudden changes when the process value (PV) is input in a pulse format.

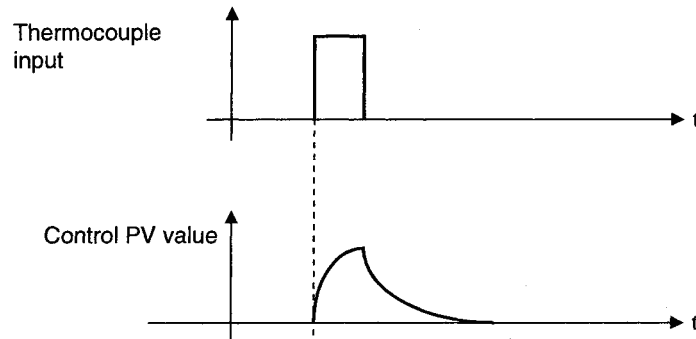

- (2) The temporary-delay digital filter setting (filter setting time) sets the time for the PV value to change to 63.3%.

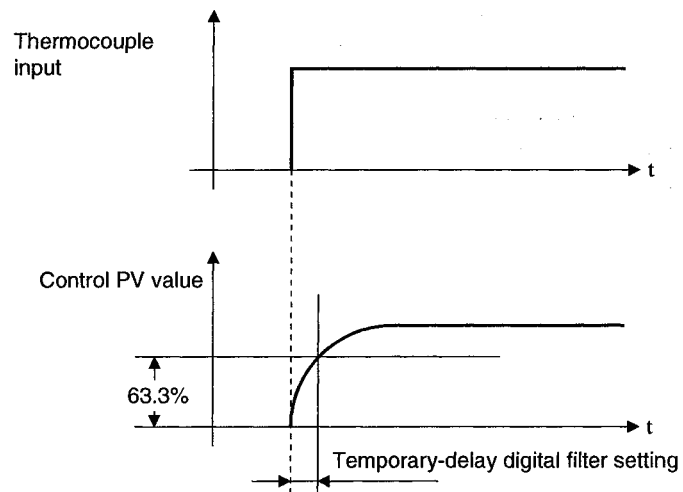

**3.6.21 Control response parameter setting (buffer memory address: 31H, 51H)**

- (1) The control response parameter is for setting the response to the PID control temperature set value (SV) changes in three levels (fast, normal, and slow).
- (a) Fast: Set to quickly respond to temperature set value changes. However, when "fast" is specified, overshoot increases.
- (b) Slow: Set when reducing the overshoot for temperature set value changes. However, the process time becomes longer.
- (c) Normal: When this is set the characteristics will be the intermediate of "fast" and "slow."

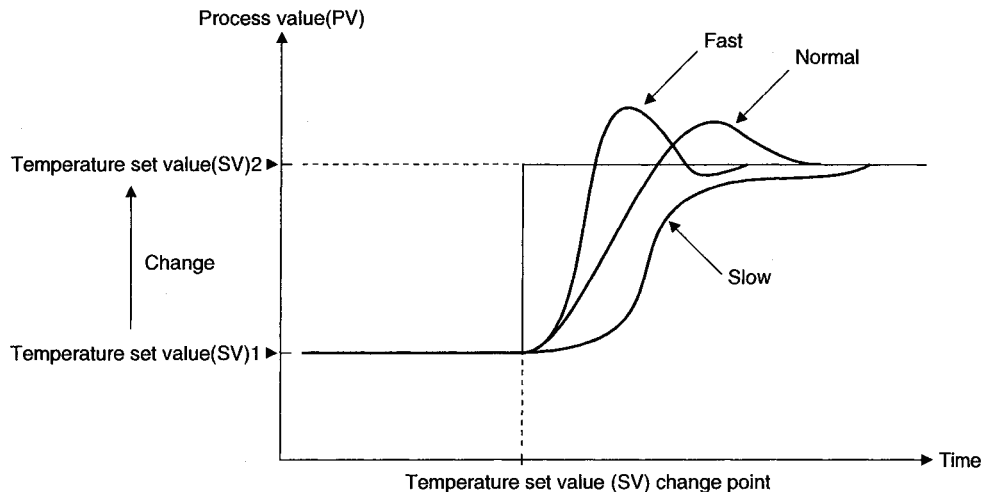
**3.6.22 Setting variation limiter setting (buffer memory address: 34H, 54H)**

- (1) This is used to set the temperature set value variation per minute when the temperature set value (SV) is changed. It has an effect to suppress the derivative kick (sudden change in the operation amount).

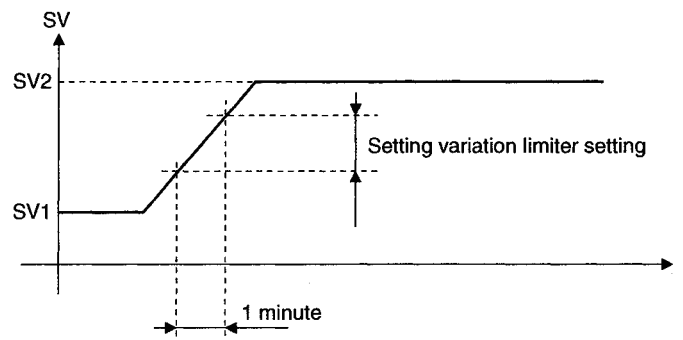

- (2) Make this setting as a percentage of the input range setting (buffer memory) address: 20H, 40H to the full scale. The setting range is 0 to 1000 (0 to 100.0%/min).

**3.6.23 Upper/Lower setting limiter (buffer memory address: 37H, 38H, 57H, 58H)**

- (1) This is used to set the upper and lower limits of the set value (SV).
- (2) Set a value within the temperature measurement range specified in the input range setting. Set so that (lower limit value) < (upper limit value).

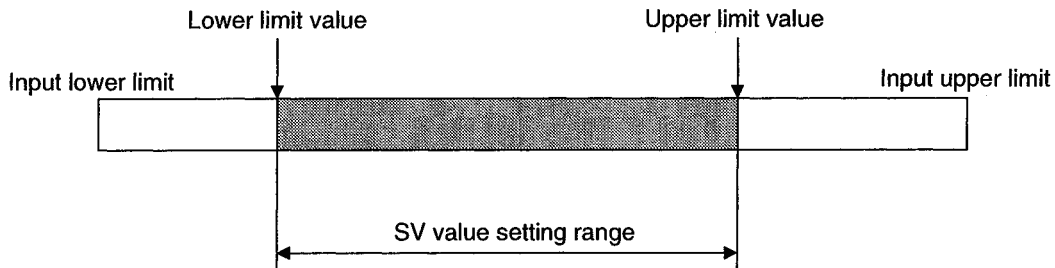

**3.6.24 CT selection (buffer memory address: 39H, 59H)**

- (1) Select the current sensor connected to the A1S62TCTTBW-S2:
  - 0: When CTL-12-S36-8 is used (0 to 100.0A)
  - 1: When CTL-6-H is used (0 to 20.00A) (The conventional model CTL-6-P is also usable.)

Point			
Only the current sensors manufactured by URD International, Ltd. can be used for the A1S62TCTTBW-S2.			
Sales shannels for current sensors manufactures by URD International, Ltd are listed as follows			
U.S.A	Julia Industries Inc. Tel: 949-831-0111	KOREA	Joyang Trading Co. Tel: 02-521-2294
BRAZIL	Ananda Industrial Ltda. Tel: 011-5584-0959		Sewon Tech Co.,Ltd. Tel: 02-868-9355/9356
UNITED KINGDOM	Omni Components Tel: 024-7622-5757		Keum Ho Corporation Tel: 51-319-4155/4156
GERMANY	Allied Electronics GmbH Tel: 0221-497-3084	HONG-KONG	Weltronics Components Ltd. Tel: 2410-0623
FRANCE	Diltronic S. A. Tel: 01-34-51-33-00	TAIWAN	Tope Co.,Ltd. Tel: 886-2-8228-0658
ITALY	ELNET s. n. c. Tel: 041-50-19-939	INDIA	AmtechElectronics PVT.Ltd. Tel: 02712-25324
Operations using other current sensors (CT) are not guaranteed.			

**3.6.25 Heater wire breakage alert setting (buffer memory address: 3AH, 5AH)**

- (1) Sets a value for when performing a heater wire breakage detection or current error detection when output is off in percentages (%) of the standard heater current value.
- (2) The setting range is 0 to 100%.  
When 0 is set, the heater wire breakage detection and the current error detection when output is off are not performed.

**3.6.26 Not used channel setting (buffer memory address: 3DH, 5DH)**

- (1) This is used when setting the channel not to perform temperature adjustment and channels not connected to a thermocouple as not used.
- (2) For the channels set as not used, the "ALM" LED does not turn on even if the thermocouple is not connected.
- (3) When the default setting registration (Y19: ON) is performed, the not nused channel setting is cleared.  
When there are channels not to perform temperature adjustment or not connected to a thermocouple, perform not used channel setting again after completing the default registration.

**3.6.27 Alert alarm 1 to 4 mode setting (buffer memory address: A0H to A3H)**

- (1) Sets the alert mode.  
When the alert alarm 1 to 4 setting buffer memory (A0H to A3H) is "0," the alert alarm is not performed.
- (2) Setting for each of the alarms 1 to 4 is performed in the buffer memory shown below:
  - Channel 1: 26H to 29H
  - Channel 2: 46H to 49H
- (3) The alert mode and the setting value are shown below:  
Refer to Section 3.3.11 for the alert alarm of A1S62TC.

Alert mode	Setting	Alert mode	Setting	Alert mode	Setting
Upper limit input alert	1	Upper limit input alert with wait	7	—	—
Lower limit input alert	2	Lower limit input alert with wait	8	—	—
Upper limit deviation alert	3	Upper limit deviation alert with wait	9	Upper limit deviation alert with re-wait	12
Lower limit deviation alert	4	Lower limit deviation alert with wait	10	Lower limit deviation alert with re-wait	13
Upper/lower limit deviation alert	5	Upper/lower limit deviation alert with wait	11	Upper/lower limit deviation alert with re-wait	14
Within the range alert	6	—	—	—	—

**3.6.28 Alert blind section setting (buffer memory address: A4H)**

Sets the blind section for alerts.

Set it within the range 0 to 100 (0.0% to 10.0%) to the full scale of the set input range.

Example) When the input range 2 (0 to 1300°C) and alert blind section setting 5 (0.5%) are selected.

$$\frac{(\text{Full scale}) \times (\text{Alert blind section})}{1000} = \frac{(1300 - 0) \times 5}{1000} = 6.5^\circ\text{C}$$

For details, refer to Section 3.3.11 (2).

**3.6.29 Number of alert delays setting (buffer memory address: A5H)**

- (1) Sets the number of alert occurrences before actually determining as an alert.
- (2) The setting range is 0 to 255.

### **3.6.30 Number of current detection delays setting when heater is wire breakage/output is off (buffer memory address: A6H)**

- (1) This is used to set how many current detection errors are generated in succession before determining an actual alert when the heater disconnection is detected and output is OFF.
- (2) The setting range is 3 to 255.

### **3.6.31 Temperature increase completion range setting (buffer memory address: A7H)**

- (1) This sets the range (difference from the set value) in which the temperature increase is determined to be complete.

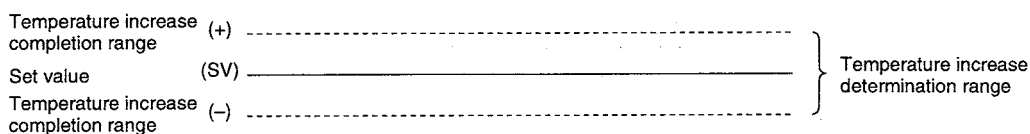

- (2) The setting range is 1 to 10°C.

### **3.6.32 Increased temperature complete soak time setting (buffer memory address: A8H)**

- (1) Sets the delay time until the temperature increase completion flag is turned on (1) after the temperature increase is complete.
- (2) The setting range is 0 to 3600 (min).

### **3.6.33 PID continue flag (buffer memory address: A9H)**

- (1) Sets the operation mode for when the setting mode/operation mode command (Y11) is turned off.
  - 0: Stop
  - 1: Continue
- (2) Refer to Section 3.3.12 for the control status by turning on and off the PID continuation flag.

### **3.6.34 Heater voltage compensation function selection (buffer memory address: AAH)**

This is a setting whether to use the heater disconnection compensation function.

- 0: Heater disconnection function is not used.
- 1: Heater disconnection function is used.

### **3.6.35 Standard heater current value (buffer memory address: ABH, ACH)**

- (1) Sets the heater ON-time heater current measurement value (buffer memory address: 19H, 1AH)
- (2) The setting ranges are indicated below.
  - When CTL-12-S36-8 is selected: 0 to 1000 (0 to 100.0A)
  - When CTL-6-P(-H) is selected: 0 to 2000 (0 to 20.00A)

**3.6.36 Transistor output monitor ON delay time setting (buffer memory address: AFH)**

---

- (1) This is set when delaying the timing to turn on the heating transistor output flag (buffer memory address: b8 of 15H, 16H).  
This is set to perform detection of heater disconnection using the input module.
- (2) The setting range is 1 to 50 (10 to 500 ms).  
When 0 is set, the heating transistor output flag (buffer memory address: b8 of 15H, 16H) does not turn on (1).

**3.6.37 CT monitor method switch (buffer memory address: B0H)**

---

- (1) Sets the method of making heater current measurement.  
Choosing the ON current/OFF current measures the present current value of the CT.  
Choosing the ON current holds (retains) the previous heater ON-time current value when the heater is OFF.
  - 0: ON current/OFF current (default)
  - 1: ON current

**3.6.38 Cooling method setting (buffer memory address: CFH)**

---

- (1) Sets an auto-tuning operation formula corresponding to the cooling efficiency of the selected cooling method.
  - 0: Air cooling (lower cooling ability)
  - 1: Water cooling (higher cooling ability)
- (2) Perform the setting before executing auto-tuning, as it affects the operation result of the PID constant for auto-tuning. (Refer to Section 3.3.2.)

**3.6.39 Overlap/dead band setting (buffer memory address: D3H, E3H)**

---

- (1) Overlap or dead band is set at the switchover point of heating and cooling control outputs. (Refer to Section 3.3.3.)
- (2) The setting range is -100 to 100 (-10.0% to 10.0%).  
Overlap or dead band is not set when 0 is specified.

# 4 Setting and Procedure Before Operation

## 4.1 Procedure Before Operation

The overview of the settings and operations before actually operating the A1S62TC is described.

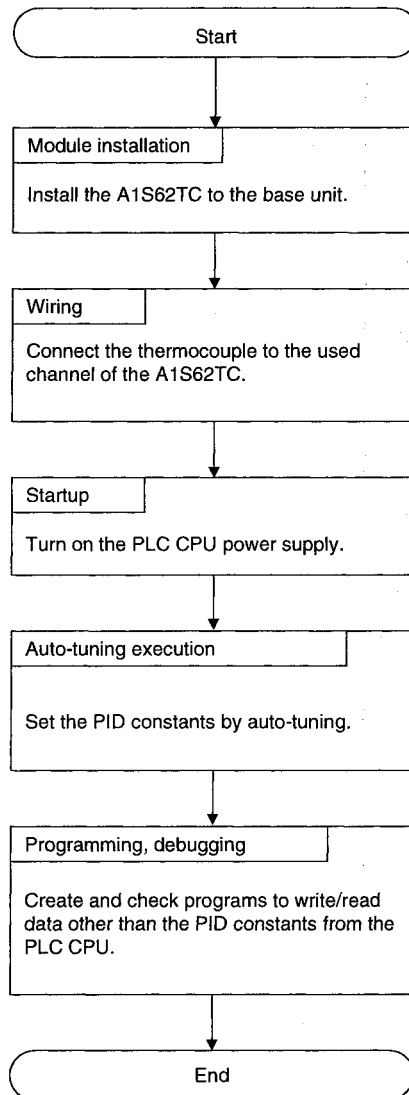

## 4.2 Precautions when Handling

Precautions when handling the A1S62TC are described below:

- (1) Since the case and terminal block of the main module are made from resin, do not drop or apply strong shock to them.
- (2) Do not remove the module print board from the case. This may cause a breakdown.
- (3) Be careful not to let foreign matters such as wire chips from the upper portion of the module during wiring. When this happens, remove the foreign matters.
- (4) Install the module and tighten the terminal screws in the following range.

Screw position	Tightening torque range
Module installation screw (M4 screw)	78 to 118N·cm
Terminal-block screw (M3.5 screw)	59 to 88N·cm
Terminal-block installation screw (M4 screw)	78 to 118N·cm
Wire breakage detection connector installation screw* (M2.6 screw)	15 to 30N·cm
Cable fixing screw* (M2 screw)	11 to 14N·cm

\*: Use only for A1S62TCTTBW-S2

- (5) When installing the module to the base, always tighten the module screws after inserting the module fixing tab to the module fixing groove. When removing, always remove the module installation screws first, then remove the module fixing tab from the groove.

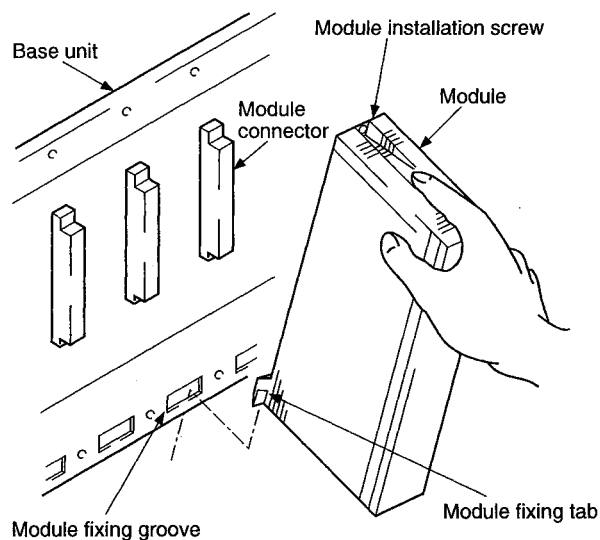



4.3 Name of Each Part

Number	Name	Description
①	<p>LED</p> <p>[A1S62TCTT-S2]</p> <p>[A1S62TCTTBW-S2]</p>	<p><b>RUN</b></p> <p>A1S62TC operation status display</p> <p>ON: Normal operation in progress</p> <p>Flashing (2s on/ 2s off): Write data error</p> <p>Flashing (1s on/ 1s off): Hardware error</p> <p>OFF: 5V power shutoff, Watchdog timer error</p>
		<p><b>OUT</b></p> <p>Transistor output display</p> <p>ON: Transistor output on</p> <p>OFF: Transistor output off</p>
		<p><b>ALM</b></p> <p>Alert alarm status</p> <p>ON: Alert alarm is on</p> <p>Flashing: Measured temperature range is exceeded</p> <p>The thermocouple is not connected</p> <p>The thermocouple cable is disconnected</p> <p>OFF: Disconnection alarm off</p>
		<p><b>BR.W</b></p> <p>Heater wire breakage detection status display</p> <p>ON: Heater wire breakage is detected</p> <p>OFF: Heater wire breakage is not detected</p>
②	Cooling contact temperature compensation resistor	Shipped pre-installed to the terminal blok
③	Wire breakage detection connector	<p>Connector for current sensor</p>

## 4.4 Wiring

---

Precautions when wiring and a module connection example are introduced.

### 4.4.1 Precautions when wiring

---

In order to use the A1S62TC functions most effectively and rise the reliability of the system, the external wiring with less chances of suffering from noise effects.

Precautions when wiring are shown below:

- (1) Use separate cables for the alternating current and the A1S62TC external input signals to prevent from receiving AC surges or induction.
- (2) Do not bundle, or near the control cables and communication cables with the main circuit and power cables. Keep them at least 100mm (3.94 inch) away from such cables. Noise may cause erroneous operation.  
Sufficiently separate cables from the circuits with high-frequency such as the high-voltage cables and inverter load main circuit.  
Failure to do so will make the cables susceptible to noise, surge, and induction.
- (3) Perform a 1-point grounding on the PLC side for the shielded line and the shielded cable.  
However, in some cases it is better to perform the grounding externally depending on the external noise conditions.

4.4.2 Module wiring example

(1) A1S62TCTT-S2

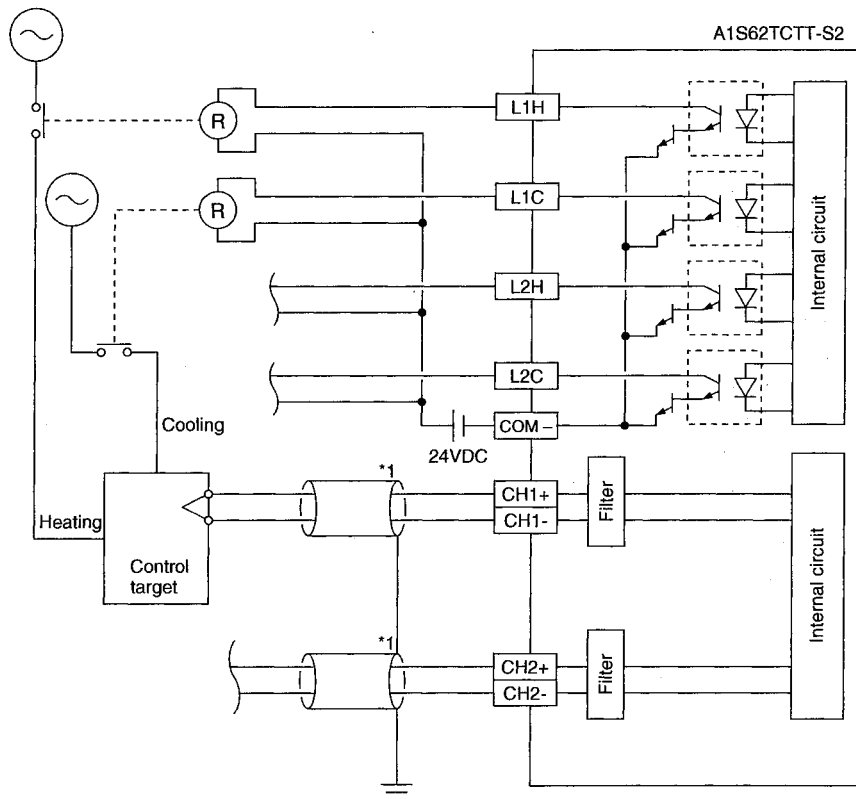

\*1: Always use the shielded compensating conductors for the cable.

(2) A1S62TCTTBW-S2

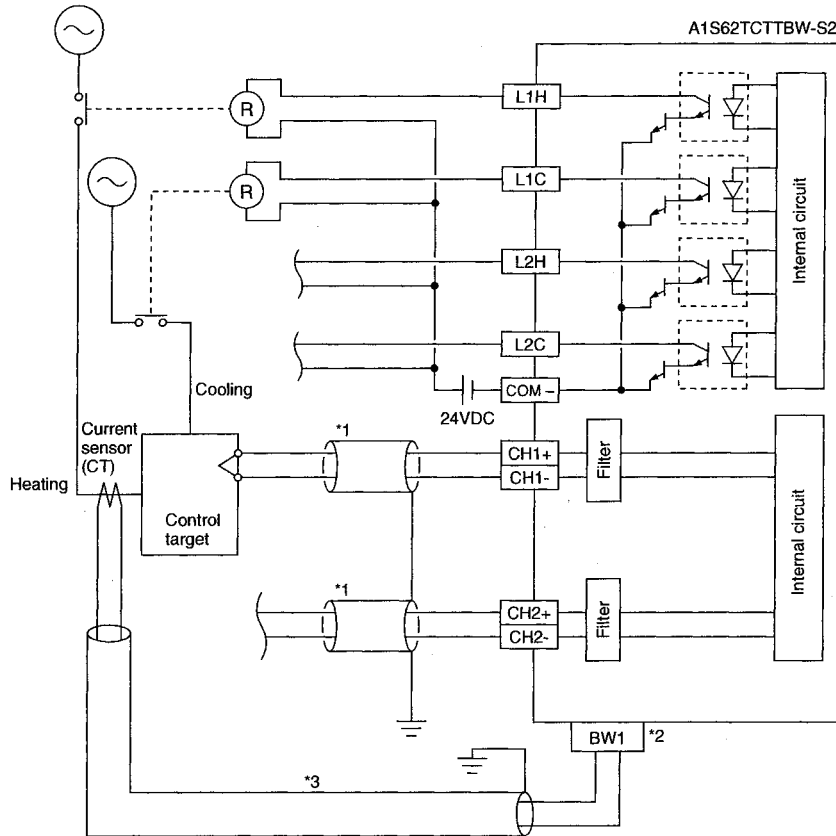

- \*1: Always use the shielded compensating conductors for the cable.
- \*2: Refer to the following for the connection of the wire breakage connector.
- \*3: Please use the cable with shield.

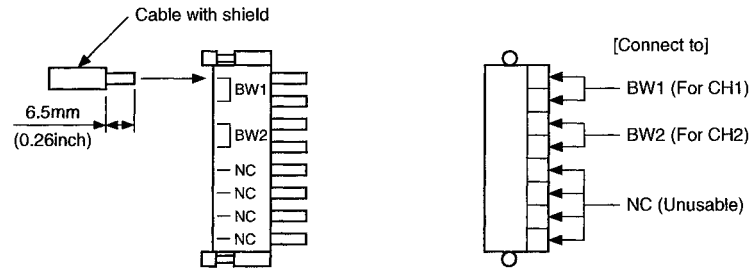

## 5 Programming

The programming procedures, standard programs to read/write, and programming example for the A1S62TC are described.

Refer to Section 3.6 for the buffer memory. For details of instructions, refer to the following manuals:

- ACPU Programming Manual
- QnACPU Programming Manual

When applying any of the program examples introduced in this chapter to the actual system, verify the applicability and confirm that no problems will occur in the system control.

### 5.1 Programming Procedure

Create a program to execute temperature adjustment with the A1S62TC in the following procedure:

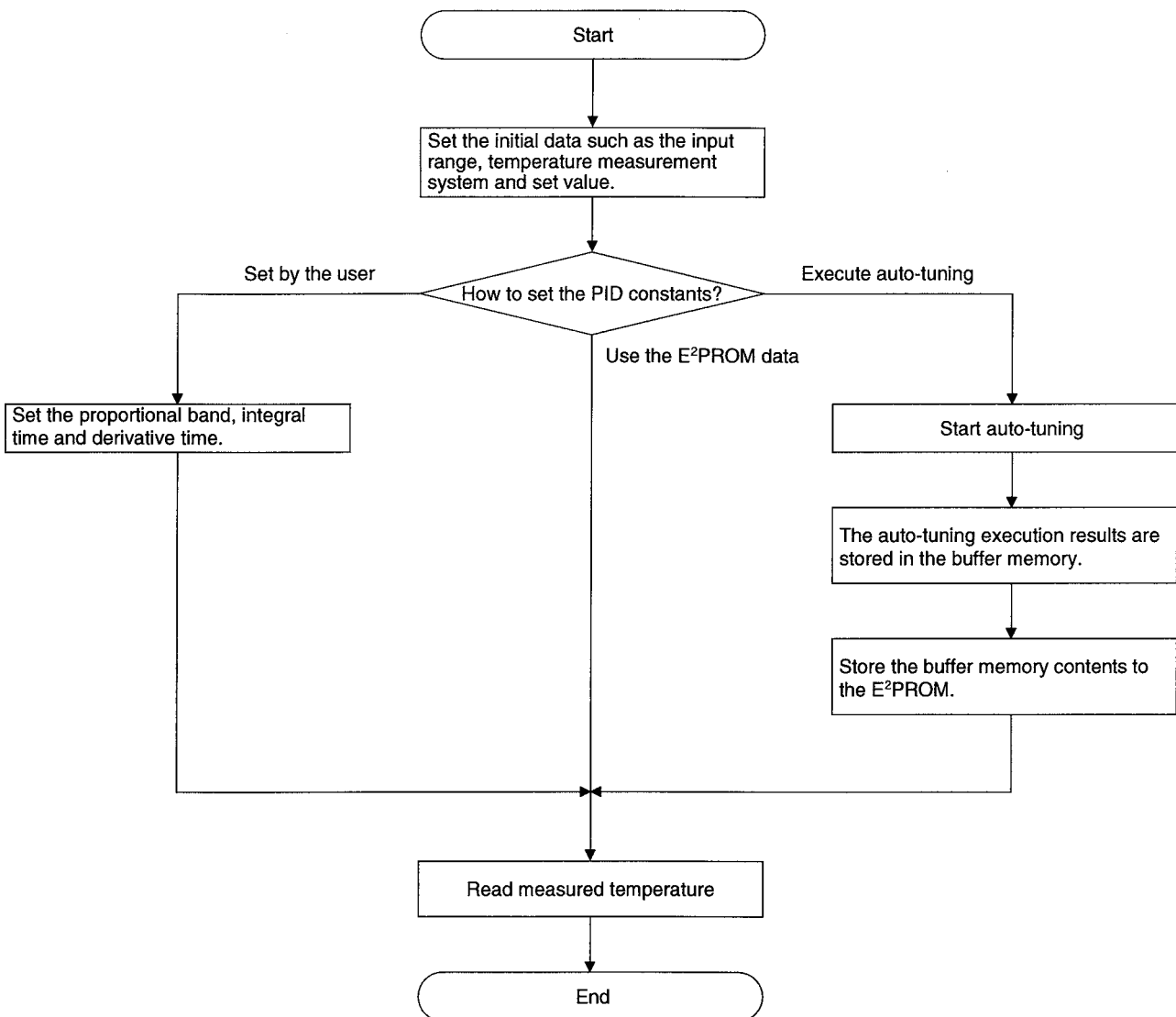

#### Point

During the various processes of a special function module, access from PLC CPU will have priority.

Accordingly, access from the PLC CPU to the buffer memory of the special function module will not only delay the scan time of the PLC CPU, it will also delay the processing of the special function module.

Only use the FROM/TO and other such instructions to access the buffer memory from the PLC CPU when necessary.

## 5.2 Program Example

The programming methods to use the A1S62TC are described.

### 5.2.1 Program to perform the initial setting and read temperature-detection value

The program reads the measured temperature after executing auto-tuning with the thermocouple (type K) connected to channel 1.

It includes programs to read the write-data error code and reset error code.

#### (1) Conditions for the program example

##### (a) System configuration

Power supply module	A1SCPU	A1SX41	A1SY42	A1S62TC		
		32 points	64 points			
		X00 to X1F	Y20 to Y5F	X/Y60 to X/Y7F	} I/O No.	

##### (b) Specification

- Set value write command ..... X0
- Auto-tuning execution command ..... X1
- Reset error code command ..... X2
- Operation mode setting command ..... X3
- Write-data error-code output (BCD 2 digits)..... Y20 to Y27
- Temperature-detection value output (BCD 4 digits)..... Y30 to Y3F
- Register for storing write-data error code ..... D50
- Register for storing temperature-detection value read ..... D51

#### (2) Program example

##### (a) Operation mode setting

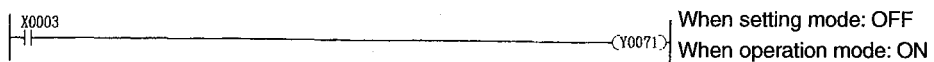

#### Point

If the input range and alert mode have been changed, move to operation mode after 1.5 seconds or more have passed. If the move is made in less than 1.5 seconds, a write error (error code 3) will be generated.

(b) Unused channel, input range, alert alarm 1, and set value, upper/lower setting limiter setting

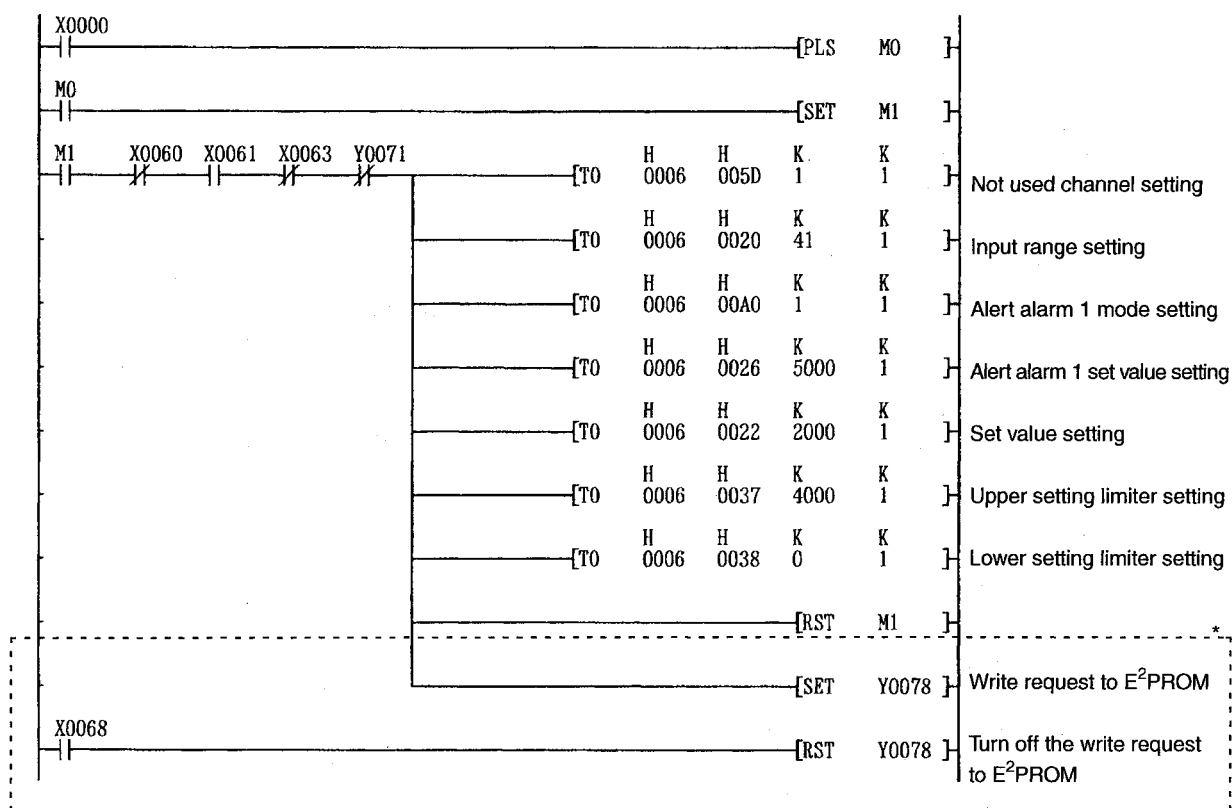

\*: Necessary to register the set input range, alert setting, and set value etc. to the E<sup>2</sup>PROM.  
 When writing the input range, alert setting, or set value etc. using the sequence program during power startup, it is not necessary to write to the E<sup>2</sup>PROM.

(c) Executing auto-tuning

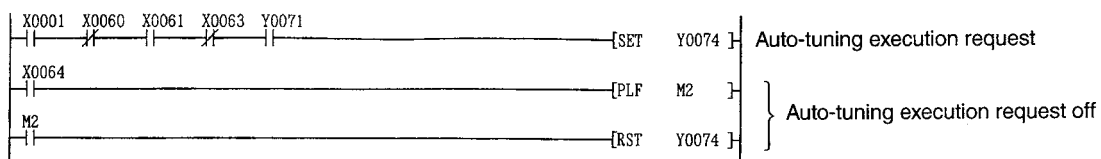

(d) Error code output and error reset

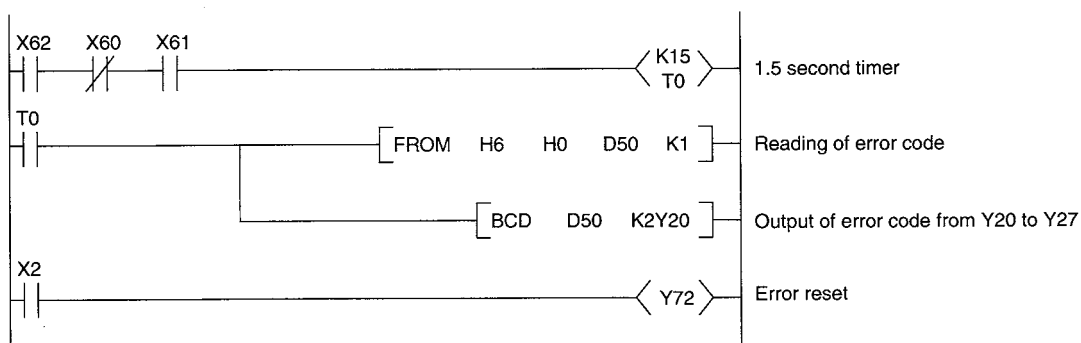

**Point**

If there have been multiple changes to the setting value, 1.5 second write errors may occur even if the correct value is written due to the checking of the adjustability with the data before changing.

If the set value has been changed, perform the writing error check after 1.5 seconds or more have passed.

Perform error reset have the occurring error has been cleared.

(e) Channel 1 temperature process value output

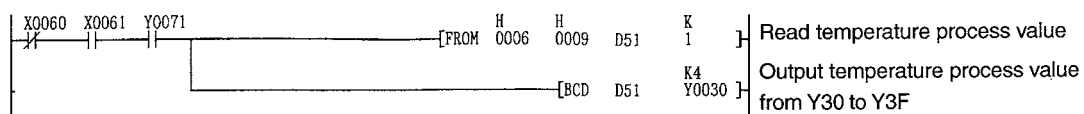



# 6 Troubleshooting

## 6.1 Error Code List

The error code for the A1S62TC is stored in the buffer memory address 0.

The error code is stored in the lower 3 bits of address 0, and the buffer memory address where the error was detected is stored in the upper 8 bits.

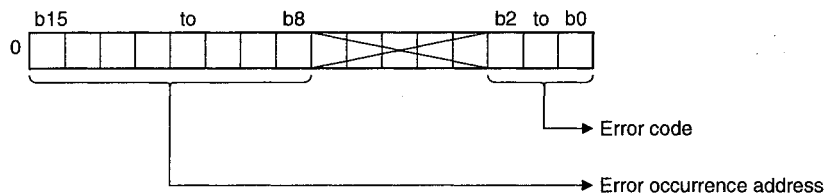

Table 6.1 Error code list

Error code (Hex.)	Cause	Actions taken when an error occurs	Corrective action
1H	<ul style="list-style-type: none"> <li>Write was executed to the area where write is not allowed (read only).</li> </ul>	<ul style="list-style-type: none"> <li>The address where the error occurred is stored.</li> <li>When the write operations were executed to multiple write areas, the address where the error was first detected is retained.</li> </ul>	<ul style="list-style-type: none"> <li>Execute the error reset (Y12: ON).</li> <li>Delete the write program which writes in a area where write is not allowed (read only).</li> </ul>
2H	<ul style="list-style-type: none"> <li>Write was executed to the unusable area.</li> </ul>	<ul style="list-style-type: none"> <li>The written data is retained as is.</li> <li>The address where the error occurred is stored.</li> <li>When the write operations were executed to multiple write areas, the address where the error was first detected is retained.</li> </ul>	<ul style="list-style-type: none"> <li>Write 0 to the address where the error occurred. (The error is reset when 0 is written.)</li> <li>Delete the write program which writes in the unusable area.</li> </ul>
3H	<ul style="list-style-type: none"> <li>Write was executed to the area during the operation mode where write is allowed only in the setting mode.</li> </ul> <p>(Operation mode: When Y11 is on, When Y11 is off and the PID continuous setting (buffer memory A9H:1) is being executed.)</p>	<ul style="list-style-type: none"> <li>The written data is retained as is.</li> <li>The operation is continued with the data prior to the write operation.</li> <li>The address where the error occurred is stored.</li> <li>When the write operations were executed to multiple write areas, the address where the error was first detected is retained.</li> </ul>	<ul style="list-style-type: none"> <li>Execute the error reset by the following procedure:                             <ol style="list-style-type: none"> <li>Change to the setting mode.</li> <li>Write the correct value.</li> <li>Execute the error reset (Y12: ON).</li> </ol> </li> <li>In order to change from the operation mode to the setting mode, turn off Y11 after setting the PID stop.</li> <li>When the error reset is executed before modifying the value of the area where write is allowed only in the setting mode, it is modified to the contents of the buffer memory.</li> </ul>
4H	<ul style="list-style-type: none"> <li>Data write was executed outside of the allowed setting range.</li> <li>When the mode setting for the alert alarm is 0, the alert alarm was set at a value other than 0.</li> </ul>	<ul style="list-style-type: none"> <li>The written data is retained as is.</li> <li>In case of the mode select item, the operation is executed using the data prior to the write operation.</li> <li>When the value exceeds the upper or lower limit in temperature, time, or percentage setting, the control is performed with the upper/lower limit value.</li> <li>The address where the error occurred is stored.</li> <li>When the write operations were executed to multiple write areas, the address where the error was first detected is retained.</li> </ul>	<ul style="list-style-type: none"> <li>Write data within the allowed setting range. (The error is reset when the data within the allowed setting range is written.)</li> </ul>
5H	<ul style="list-style-type: none"> <li>Setting of the upper/lower setting limiter is invalid.</li> </ul>	<ul style="list-style-type: none"> <li>The written data is retained as is.</li> <li>Allowed upper and lower values are used for the control.</li> <li>The address where the error occurred is stored.</li> <li>When the write operations were executed to multiple write areas, the address where the error was first detected is retained.</li> </ul>	<ul style="list-style-type: none"> <li>Modify the upper/lower setting limiter so that the lower limit value is less than the upper limit value.</li> </ul>
6H	<ul style="list-style-type: none"> <li>The set value was modified during the default setting registration.</li> </ul>	<ul style="list-style-type: none"> <li>The written data is ignored.</li> <li>Modification of the set value is not allowed until the error is reset.</li> <li>The address where the error occurred is stored.</li> <li>When another write error occurs, the error code does not change but the error address is overwritten by the address of the new write error.</li> </ul>	<ul style="list-style-type: none"> <li>Modify the set value after the error reset (Y12: ON).</li> </ul>

**Remarks**

- 1) When the data beyond the setting range is written in the input range area or in the alert mode area during the setting mode, the error code "4" is stored.  
When it is changed to the operation mode without resetting the error, the error code is changed to "3".  
In this case, execute the error processing for the error code "3".
- 2) Priorities of the errors are as follows:  
When a high-priority error occurs while a low-priority error has already occurred, the error code and the error address of the high-priority error write over those of the low-priority error.

[Priority]

6 ← 1 ← 3 ← 5 ← 2/4

High

Low

(Between the errors 2 and 4, the error with the lower error address has priority.)

**6.2 The A1S62TC Processing During Error**

The details of the A1S62TC processing when an error occurs with the A1S62TC or PLC CPU and when the PLC CPU is changed from RUN to STOP are described.

Status		Processing details	
		Output status setting when in the setting mode (buffer memory address: A9H)	
		PID stop	PID continue
When an A1S62TC error occurs	When an error which continues operations occurs such as write error	The operation is continued with data before the write that caused the write error at the buffer memory address, and external output is performed.	
During reset of PLC CPU			
When PLC CPU error occurs	When an error which stops the PLC CPU operations occurs	Stops operation and turns off external output.	
	When an error which continues the PLC CPU operations occurs	Continues operation and performs external output.	
PLC CPU RUN → STOP			
When the remote I/O station has a link error (when installed to a remote I/O station)		Stops operation and turns off the external output.	Continues operation and performs external output.

**⚠ DANGER**

- Take sufficient caution when setting the PID continue flag which controls external output.
- Erroneous output may be made due to the output element or internal circuit malfunction.  
For output signals that may cause significant damage, configure a circuit which monitors them externally.

### 6.3 When the A1S62TC RUN LED Flashes or Turns OFF

#### (1) When flashing

Check item	Corrective action
2s on/ 2s off Isn't the write data error flag (X2) on?	<ul style="list-style-type: none"> <li>Check the error code list in Section 6.1 and correct the sequence program.</li> </ul>
1s on/ 1s off Hardware error	<ul style="list-style-type: none"> <li>There is an A1S62TC hardware error. Return the hardware to the nearest retail store or corporate office.</li> </ul>

#### (2) When turned off

Check item	Corrective action
Is the 5VDC supplied?	<ul style="list-style-type: none"> <li>Check the power module.</li> <li>Install the module securely.</li> </ul>
Confirm if the current capacity total of the modules installed to the base unit is below the power supply module's current capacity.	<ul style="list-style-type: none"> <li>Set the current capacity total of the modules installed to the base unit below the current capacity of the power supply module.</li> </ul>
Isn't the watchdog timer error (X0) on?	<ul style="list-style-type: none"> <li>Perform a reset or restart power supply again for the PLC CPU.</li> <li>Replace the A1S62TC.</li> </ul>

### 6.4 When the ALM LED is Turned ON or Flashing

#### (1) When turned on

Check item	Corrective action
Check if there is a channel where the thermocouple is not connected.	<ul style="list-style-type: none"> <li>Set the channel, where the thermocouple is not connected, to unused in the buffer memory addresses 3DH, 5DH.</li> </ul>
Check if the alert flag (XC, XD) is turned on.	<ul style="list-style-type: none"> <li>Check buffer memory addresses 5H, 6H, then take steps depending on the contents.</li> </ul>

#### (2) When flashing (ON for one second and OFF for one second)

Check item	Corrective action
Check if the process value exceeds the measurement temperature range specified in the input range setting.	<ul style="list-style-type: none"> <li>Change the input range setting to the temperature range in use.</li> </ul>

### 6.5 When the Temperature Adjustment Ready Flag (X1) is not Turned ON

Check item	Corrective action
Check if the watchdog timer error (X0) is on.	<ul style="list-style-type: none"> <li>Reset the PLC CPU or turn the power off and on.</li> <li>Replace the A1S62TC.</li> </ul>
Check if there is an error in the PLC.	<ul style="list-style-type: none"> <li>Take steps by referring to the user's manual of the used CPU.</li> </ul>

**6.6 When the Write Data Error Flag (X2) is ON**

Check item	Corrective action
Check if a write data error has occurred.	<ul style="list-style-type: none"> <li>Check the error code summary in Section 6.1, then modify the sequence program.</li> </ul>

**6.7 When the H/W (hardware) Error Flag (X3) is ON**

Check item	Corrective action
Hasn t the cold junction compensation resistor been removed?	Connect the cold junction compensation resistor.
—	<ul style="list-style-type: none"> <li>Hardware error of the A1S62TC. Please return it to the nearest dealer or branch office.</li> </ul>

**6.8 When the Alert Flag (XC, XD) is ON**

Check item	Corrective action
Check if the measurement temperature error/alert set value is exceeded the allowable range.	<ul style="list-style-type: none"> <li>Check the buffer memory addresses 5H, 6H, then take steps depending on the contents.</li> </ul>
Check if a wire breakage is detected.	

# Appendix

## Appendix 1 External Dimensions

(1)A1S62TCTT-S2

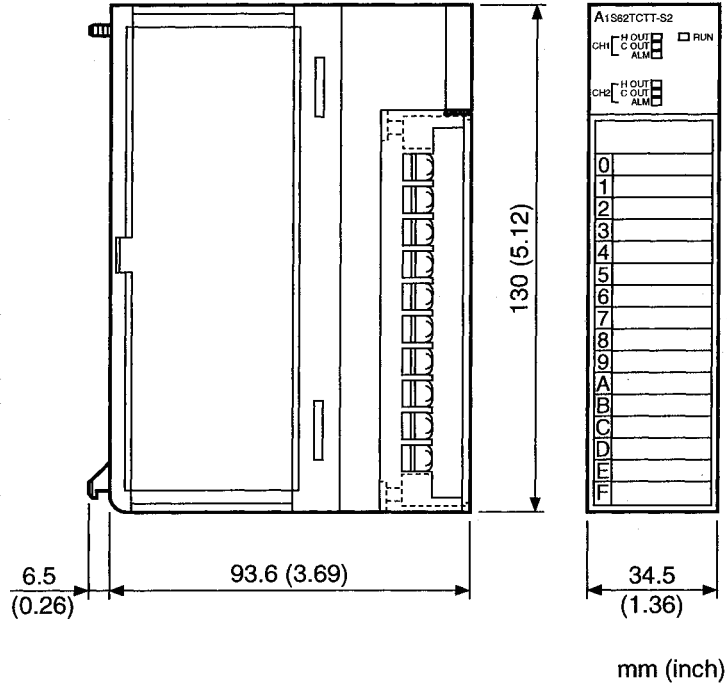

(2)A1S62TCTTBW-S2

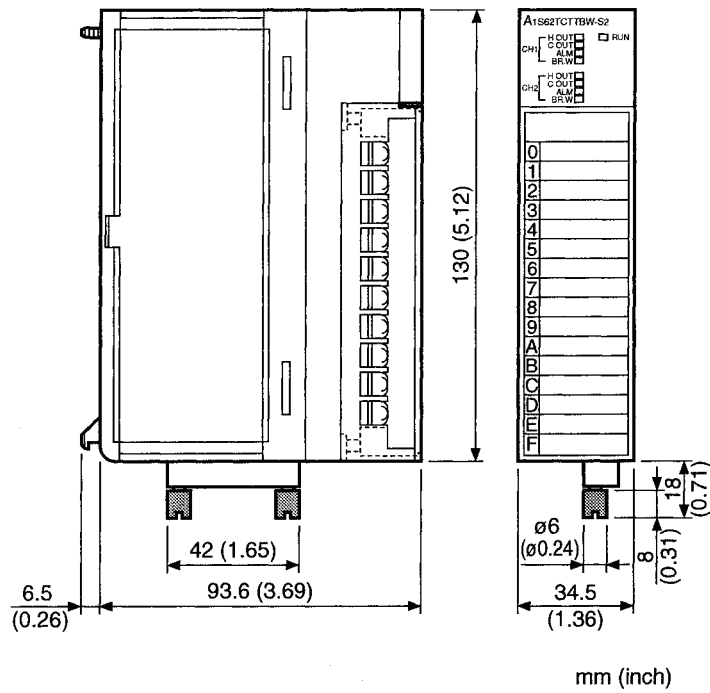

# WARRANTY

Please confirm the following product warranty details before using this product.

## 1. Gratis Warranty Term and Gratis Warranty Range

If any faults or defects (hereinafter "Failure") found to be the responsibility of Mitsubishi occurs during use of the product within the gratis warranty term, the product shall be repaired at no cost via the sales representative or Mitsubishi Service Company.

However, if repairs are required onsite at domestic or overseas location, expenses to send an engineer will be solely at the customer's discretion. Mitsubishi shall not be held responsible for any re-commissioning, maintenance, or testing on-site that involves replacement of the failed module.

### [Gratis Warranty Term]

The gratis warranty term of the product shall be for one year after the date of purchase or delivery to a designated place.

Note that after manufacture and shipment from Mitsubishi, the maximum distribution period shall be six (6) months, and the longest gratis warranty term after manufacturing shall be eighteen (18) months. The gratis warranty term of repair parts shall not exceed the gratis warranty term before repairs.

### [Gratis Warranty Range]

- (1) The range shall be limited to normal use within the usage state, usage methods and usage environment, etc., which follow the conditions and precautions, etc., given in the instruction manual, user's manual and caution labels on the product.
- (2) Even within the gratis warranty term, repairs shall be charged for in the following cases.
  1. Failure occurring from inappropriate storage or handling, carelessness or negligence by the user. Failure caused by the user's hardware or software design.
  2. Failure caused by unapproved modifications, etc., to the product by the user.
  3. When the Mitsubishi product is assembled into a user's device, Failure that could have been avoided if functions or structures, judged as necessary in the legal safety measures the user's device is subject to or as necessary by industry standards, had been provided.
  4. Failure that could have been avoided if consumable parts (battery, backlight, fuse, etc.) designated in the instruction manual had been correctly serviced or replaced.
  5. Failure caused by external irresistible forces such as fires or abnormal voltages, and Failure caused by force majeure such as earthquakes, lightning, wind and water damage.
  6. Failure caused by reasons unpredictable by scientific technology standards at time of shipment from Mitsubishi.
  7. Any other failure found not to be the responsibility of Mitsubishi or that admitted not to be so by the user.

## 2. Onerous repair term after discontinuation of production

- (1) Mitsubishi shall accept onerous product repairs for seven (7) years after production of the product is discontinued. Discontinuation of production shall be notified with Mitsubishi Technical Bulletins, etc.
- (2) Product supply (including repair parts) is not available after production is discontinued.

## 3. Overseas service

Overseas, repairs shall be accepted by Mitsubishi's local overseas FA Center. Note that the repair conditions at each FA Center may differ.

## 4. Exclusion of loss in opportunity and secondary loss from warranty liability

Regardless of the gratis warranty term, Mitsubishi shall not be liable for compensation of damages caused by any cause found not to be the responsibility of Mitsubishi, loss in opportunity, lost profits incurred to the user by Failures of Mitsubishi products, special damages and secondary damages whether foreseeable or not, compensation for accidents, and compensation for damages to products other than Mitsubishi products, replacement by the user, maintenance of on-site equipment, start-up test run and other tasks.

## 5. Changes in product specifications

The specifications given in the catalogs, manuals or technical documents are subject to change without prior notice.

## 6. Product application

- (1) In using the Mitsubishi MELSEC programmable logic controller, the usage conditions shall be that the application will not lead to a major accident even if any problem or fault should occur in the programmable logic controller device, and that backup and fail-safe functions are systematically provided outside of the device for any problem or fault.
- (2) The Mitsubishi programmable logic controller has been designed and manufactured for applications in general industries, etc. Thus, applications in which the public could be affected such as in nuclear power plants and other power plants operated by respective power companies, and applications in which a special quality assurance system is required, such as for Railway companies or Public service purposes shall be excluded from the programmable logic controller applications.

In addition, applications in which human life or property that could be greatly affected, such as in aircraft, medical applications, incineration and fuel devices, manned transportation, equipment for recreation and amusement, and safety devices, shall also be excluded from the programmable logic controller range of applications.

However, in certain cases, some applications may be possible, providing the user consults their local Mitsubishi representative outlining the special requirements of the project, and providing that all parties concerned agree to the special circumstances, solely at the users discretion.



A1S62TCTT-S2 Heating-Cooling Temperature Control Module  
A1S62TCTTBW-S2 Heating-Cooling Temperature Control Module  
with Wire Breakage Detection Function

# User's Manual

MODEL	A1S62TCTTS2-U-E
MODEL CODE	13JL35
SH(NA)-3643-E(0603)MEE	



HEAD OFFICE : TOKYO BUILDING, 2-7-3 MARUNOUCHI, CHIYODA-KU, TOKYO 100-8310, JAPAN  
NAGOYA WORKS : 1-14, YADA-MINAMI 5-CHOME, HIGASHI-KU, NAGOYA, JAPAN

When exported from Japan, this manual does not require application to the Ministry of Economy, Trade and Industry for service transaction permission.

Specifications subject to change without notice.